

# SGH Syntax<sup>®</sup>

**GIGAMOD HYBRID CONNECTOR SERIES**

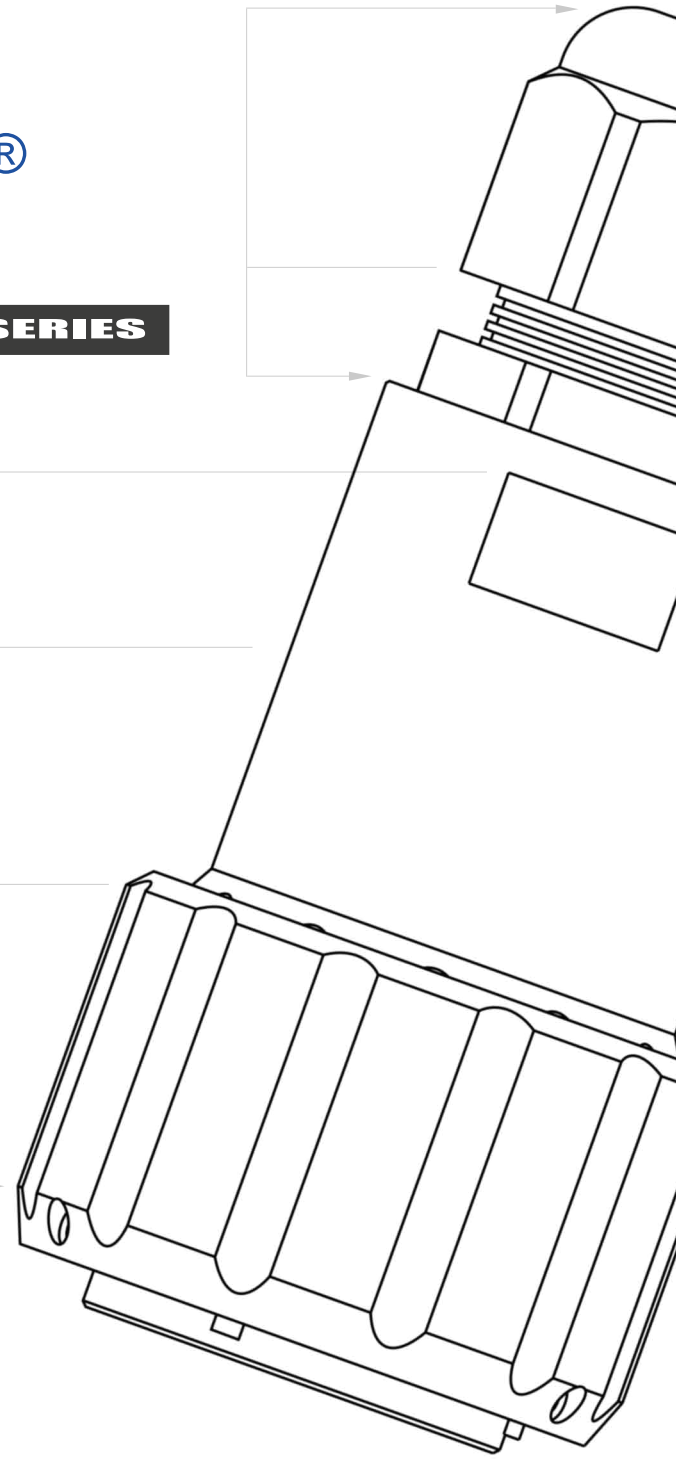

Your idea  
is our next  
accomplishment



**Syntax<sup>®</sup>**  
**Gigamod**  
**Hybrid**

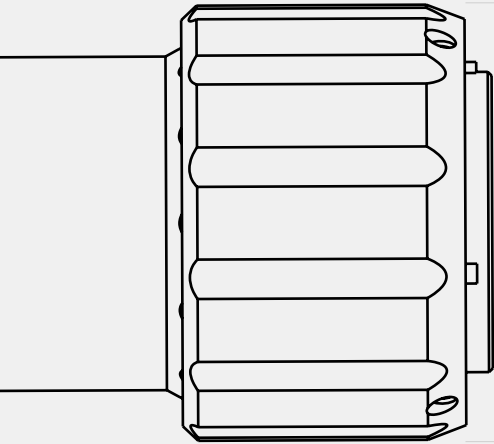

**VALENTINI**

*SYNTAX*®  
*PBOX*

## **Inventors, manufacturers, innovators.**

Valentini is a dynamic, ever-evolving company operating in over 60 countries worldwide. For more than 30 years we have actively researched, designed and manufactured connectors for power, signal and hybrid applications.

Our products have been used all over the world to manage power and electric signals in fields such as industry, automotive, broadcasting, shipbuilding & ship to shore power, international sporting events, live shows, military & national emergency management by agencies such as the Italian Civil Protection Department, and so many more.

Valentini is an environmentally-aware company where respect for the environment is an integral part of the manufacturing process. Our team is motivated and mindful of details, as we are aware of how important details are in our pursuit of uncompromised quality and utmost reliability.

# INDEX

## 04 Syntax Gigamod Hybrid series

Typical applications  
Exploded view example  
Technical features

## 06 The SGH shielding philosophy

Shield propagation  
Syntax Safe Tunnels

## 12 SGH versions

8.1 Inline and panel version  
16.1 Inline and panel version  
Perforated backshell for panel connectors  
SGH 8.1 and 16.1 Multiway  
Multiway possible use cases  
Overall dimensions

## 18 Modules & contacts

Signal, blank and power central inserts  
Capsulock power contacts  
Tunnel modules

## 23 Syntax Wireasy Technology

## 24 Cable protection and management

Wire mesh strain relief | Hanger grip | Pulling grip

## 27 Metric cable glands and IP67 caps

## 28 SGH possible use cases

## 38 Syntax Cables for SGH series

## 42 Syntax tools

## 44 Part Number explanation





# Syntax® SGH

connectors series

## Syntax Gigamod Hybrid modular circular connectors

For connectors it was either easy or hybrid, the bitter truth everyone in the industry knew. We are definitely not the first manufacturers who made a hybrid connector, but we are the first who invented a hybrid connector that is fast and easy to wire for everyone. No longer hybrid or fast. It's hybrid and fast, finally, with 10GBASE-T as the icing on the cake. This is where Syntax Gigamod Hybrid leads the way.

## Ethernet/HDMI/USB3 and Power

A central insert carrying power or digital signals and a circular outer shell with up to 16 contact modules for multiple Ethernet, HDMI, USB3 signals. Mechanically interlocked elements that open up a world of possibilities for your jobs in so many fields.

Combine them and create your solution. Imagine the limitless applications of a multimodule connector for Ethernet/HDMI/USB3 signals also carrying a central module for power or additional signals.

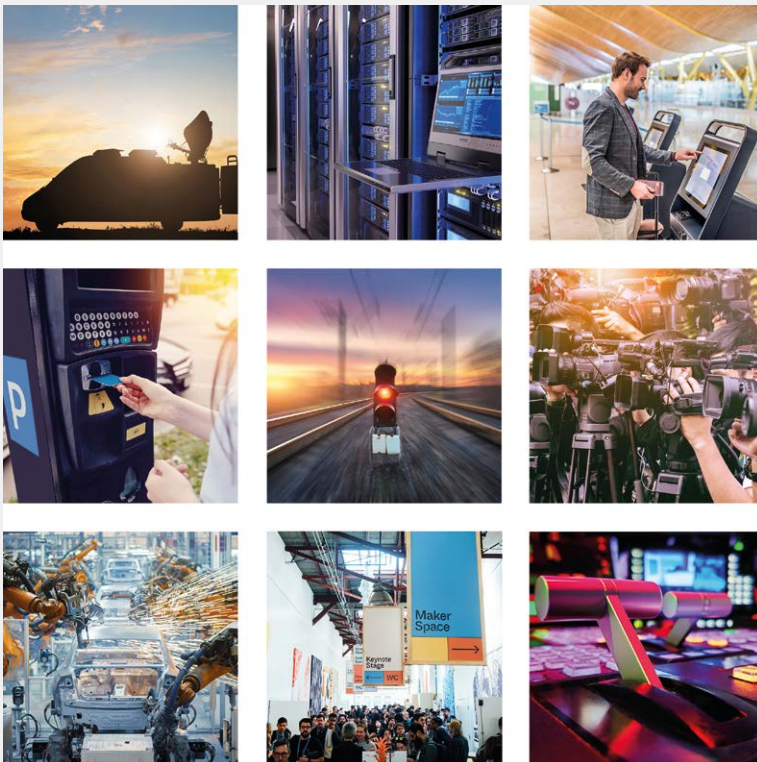

## Typical applications

- Shipment and logistics
- Automated kiosks
- Industrial automation
- Biomedical equipment
- Transport networks
- Electronic payments
- Infopoints
- Access control points
- Networks management
- Law enforcement, military and civil protection situation rooms
- TV and radio broadcast
- Live entertainment
- Live events
- Conferences
- Surveillance networks

## Exploded view example SGH 16.1 Inline Male

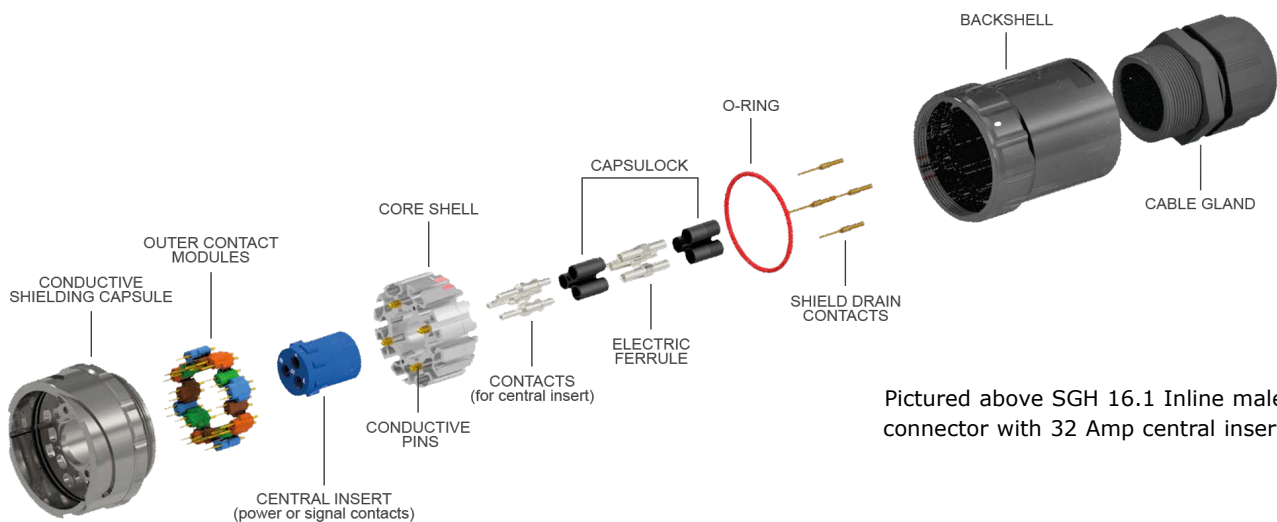

### Syntax Shield propagation

From cable to cable, the general shield is drained and propagated through a conductive, precision CNC machined core shell. It's as if your cables had never been interrupted!

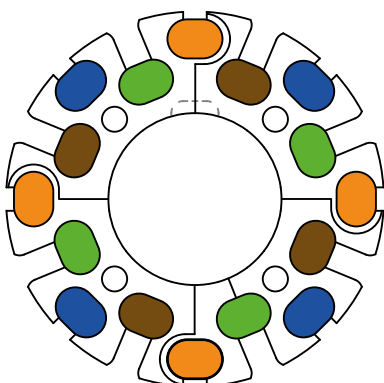
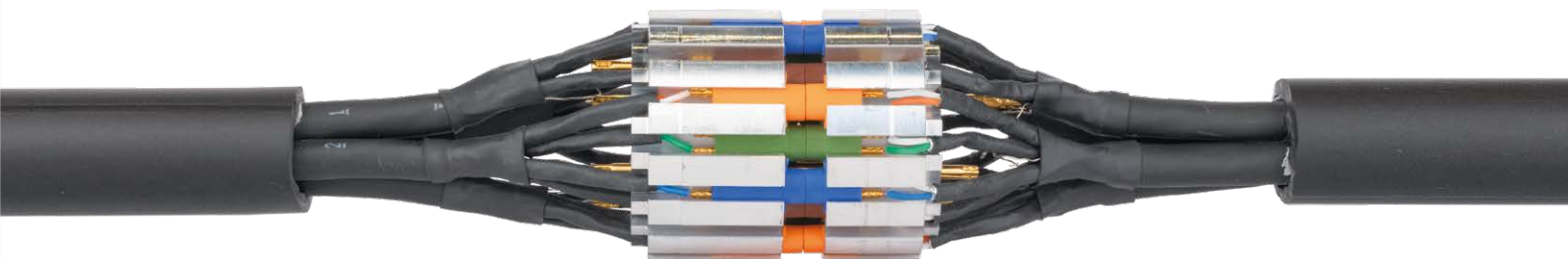
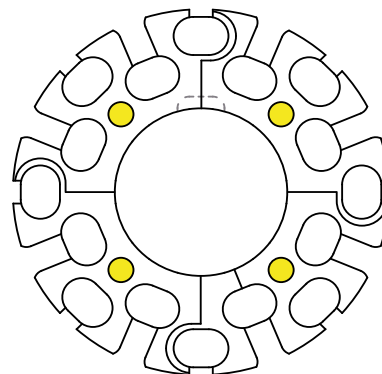

### Syntax Safe Tunnels

A barrier against crosstalk to protect each one of the signal pairs after their shields have been removed for wiring purposes. Every core element has several openings, one for each pair of signal conductors, leading to tunnels that cross the core through all its length.



# The perfect combo for a flawless shielding

Shield propagation & Syntax Safe Tunnels

Discover all the elements that give shape to an ingenious solution. A new philosophy for shield continuity from cable to cable, as if there were no connectors at all, combined with the Syntax Safe Tunnels, providing protection from external noise and insulation between signal conductors.



# Shield propagation

Discover the highlights of a new shielding philosophy

From cable to cable, the general shield is drained and propagated through a conductive, precision CNC machined core shell.

Conductive pin

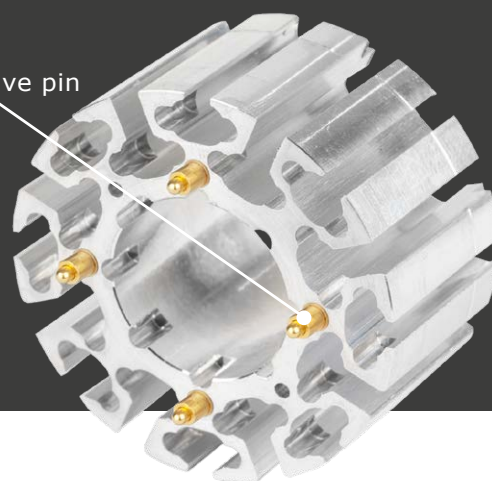

## 1. The issue: getting shield continuity

Each of the twisted pairs that make up the signal conductors running inside the ethernet cables is aluminium mylar foil shielded all along. However, a small portion of the aluminium foil must be removed to untwist the pairs, crimp the contacts, insert them in the corresponding modules and place the contact modules inside the core shell. Along that very short stretch of cable with the mylar foil removed, shield continuity is interrupted. That's exactly where the issue would arise...

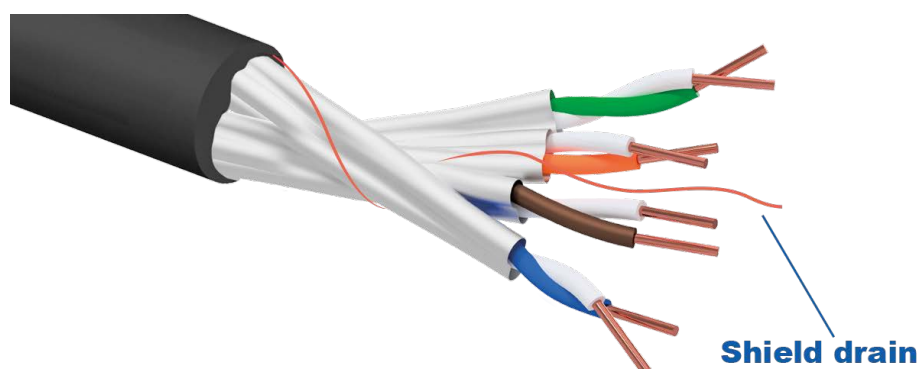

## 2. Core shell as a shield

The shell at the heart of the Syntax SGH series is indeed the core of the system. Not only it is a precision machined element housing the modules where the contacts are withheld; even more important than that is its function as an active component of the connector's shielding system.

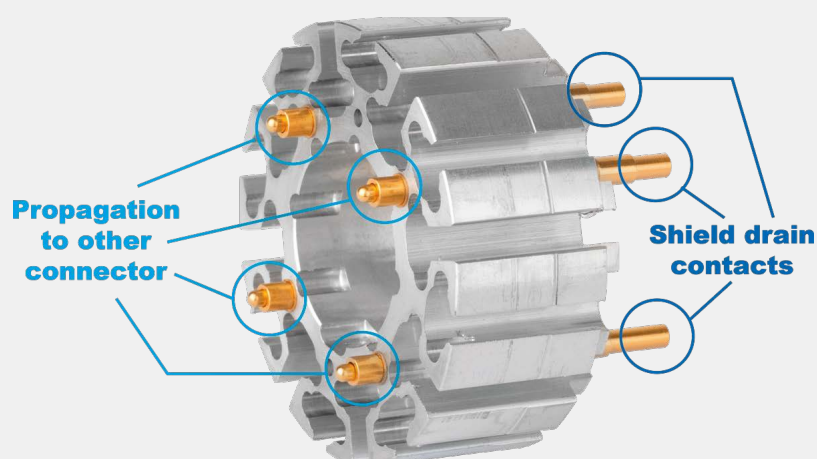

### 3. Shield draining

After a small portion of the aluminium foil has been removed (as described at # 1), the ethernet pairs are no longer fully shielded. For shield continuity, the drain wire of each ethernet pair is crimped onto a specific shield drain contact (a male pin) connected to a shield propagator (a female socket) inserted in the core element. For each ethernet line, there is a shield drain contact and a corresponding shield propagator.



### 4. The conductive pins

Shield propagation between the two connectors is ensured by four new and improved conductive pins. The male pins have been carefully designed and machined with springs inside to help provide optimal contact quality to the corresponding females, even in rough working conditions. The application of this new pin design results in enhanced reliability and performances of our shielding solution.

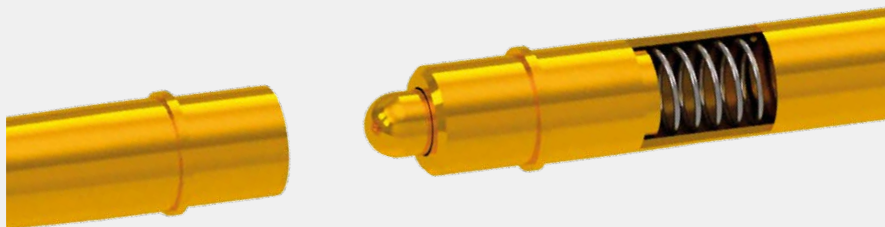

### 5. Full shield propagation

The Syntax SGH connector's outer capsule has a conductive galvanic surface. Thanks to the combined action of the shield propagating contacts and the conductive treatment on the surface of the capsule, full shield propagation is obtained from cable to cable through the mated SGH connectors. It's as if your cables had never been interrupted!



# Syntax Safe Tunnels

## Reciprocal interference and noise protection

A powerful set of features to protect your data transmission.



## A Safe place for signals

### Protecting what is most valuable

**Every core element has several openings, one for each pair of signal conductors, leading to tunnels that cross the core through all its length. The Syntax Safe Tunnels play a decisive role in shielding our Syntax SGH connectors from any internal and external interferences.**

The main purpose of an effective shielding solution is to protect all signals from interferences. In fact, external noise is a common issue on connectors and must be addressed properly. In a hybrid, modular, feature-rich connector as our Syntax SGH is, the main challenge is indeed to prevent any cross interference between signal conductors running close to each other. That's why we came up with an innovative design that not only solves problems related to interferences, it also allows quick wiring operations.

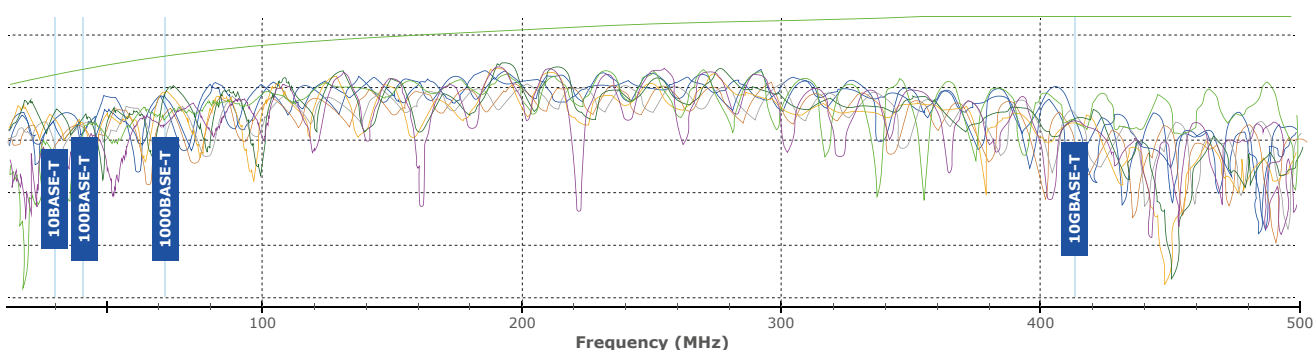
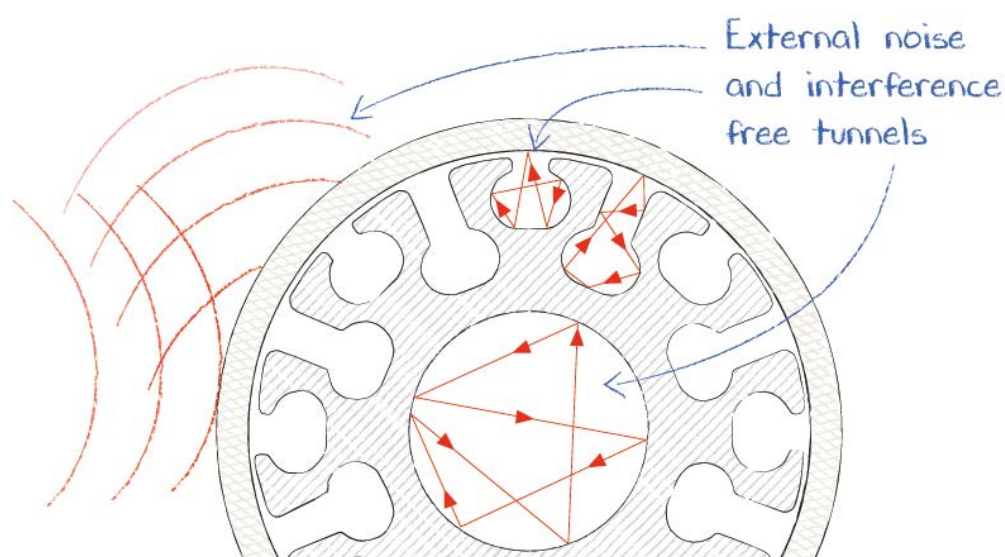

**Network compliance: 10BASE-T, 100BASE-T, 1000BASE-T, 10GBASE-T**

# 1. The issue: being free from interference

Each of the twisted pairs inside the ethernet cables is aluminium foil shielded all along. However, a small portion of the foil must be removed to untwist the pairs, crimp the contacts, insert them in the corresponding modules and place the contact modules inside the core shell. Along that very short stretch of cable, with the pairs no longer twisted and their shield removed, it would be as if the wires were totally exposed to interferences.

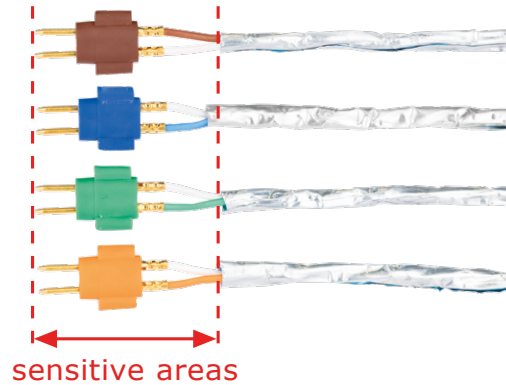

# 2. Active shielding at the core

The shell at the heart of the Syntax SGH series is indeed the core of the system. Not only it is a precision-machined element housing the modules where the contacts are withheld; even more important than that is its function as an active component of the connector's shielding system.



# 3. Inside the tunnels

The "no longer twisted" ethernet pairs, now crimped and locked in the contact modules, are channeled along the tunnels of the core element that serves as their housing.

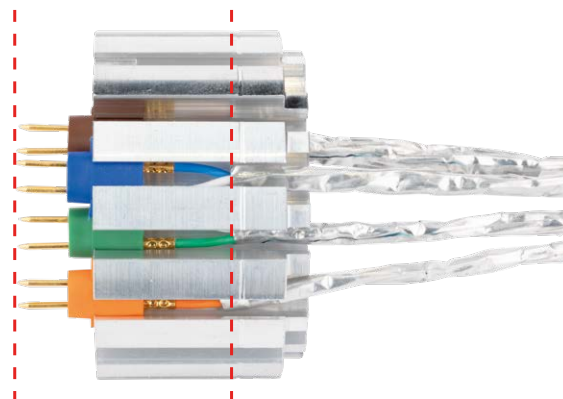



## 4. Behind thick walls

When modules and cables are in place, the thick inner walls of the Syntax Safe Tunnels provide a barrier against reciprocal interferences (crosstalk) between the pairs placed in each tunnel.



## 5. Sealing it all with a capsule

The sensible areas shown at point 1, however, would still be partially exposed to reciprocal interferences, as the gaps in the slots allowing easy access for the wires inside the tunnels would impede complete shielding. A specifically designed capsule seals the slots on the outer side of the tunnels, creating an area totally free from crosstalk, reduced Next/Fext level. Thanks to its conductive galvanic surface, the capsule is a double-purpose element also providing complete shield propagation from cable to cable through the mated SGH connectors.

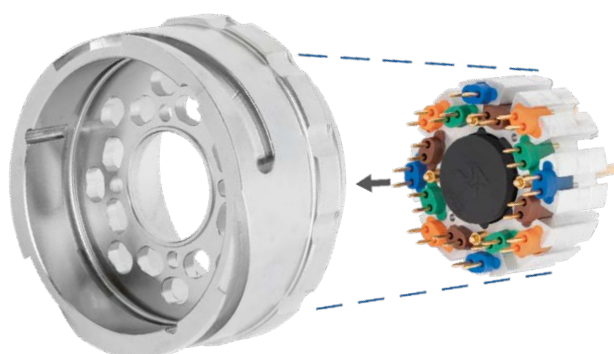

## 6. The assembled structure

When the capsule is in place and mated with a second connector, the complete shielding structure extends from the starting cable through the connector and onto the next connector to the destination cable.





# Syntax<sup>®</sup> SGH versions

Inline and panel

Syntax Gigamod Hybrid is a groundbreaking innovation in the world of hybrid connections. It is a modular, adaptable solution providing versatile connections for multiple fields of application. Syntax SGH allows simultaneous connectivity for power, controls, signaling and monitoring systems. The innovation of this technology is centered on a very simple idea: wiring and using this connector must be quick and easy for everyone. We did the dirty work, we invented a complex engineering solution and left the clean part for you: reliable, intuitive, easy-to-use circular connectors, suitable and easy to handle in any situation.

## Syntax SGH connectors

### 8.1 and 16.1 | Inline and panel | Male and Female

All connectors, both inline and panel, are available in male and female versions.



## A perforated backshell for secure wiring

### for Panel versions

A proprietary system providing support and stability to cables. The perforated backshell of the SGH panel-mount connectors is threaded to the flange of the connector and is designed to provide extra safety for the fastening of the wired cables. The cables are tied to the holes located around the circumference, preventing damages to the internal components due to the weight of the cable.

This innovative yet simple feature allows steady fastening of the wiring to the backshell through common cable ties, in order to protect the cables and manage the internal wiring in an orderly fashion, thus providing added cable strain relief and preventing the risk of electrical damage.



**Front view**  
Backshell with cables



**Rear view**  
Backshell with cables



# SGH 8.1 and 16.1 Multiway

## Grommet System

The Syntax proprietary multiway rubber grommets are directly fitted in the cable gland of the inline connectors to guarantee optimal cable retention and IP67 watertight seal for outdoor use.



## Grommets for SGH 8.1

### 3-way and 6-way

Compatible with M40 cable glands



**3-way Special Grommet**  
2 Lan + 3x2.5 (16amp 3p)



**3-way Special Grommet**  
2 Lan + 3x6 (32amp 3p)  
2 Lan + 5x2.5 (16amp 5p)



**6-way Special Grommet**  
2 Lan + 4 digit

## Grommets for SGH 16.1

### 5-way and 8-way

Compatible with M40 cable glands



**5-way Special Grommet**  
4 Lan + 3x2.5 (16amp 3p)



**5-way Special Grommet**  
4 Lan + 3x6 (32amp 3p)  
4 Lan + 5x2.5 (16amp 5p)



**8-way Special Grommet**  
4 Lan + 4 digit

## Possible use cases for SGH connectors and multiway solutions

### SGH 8.1

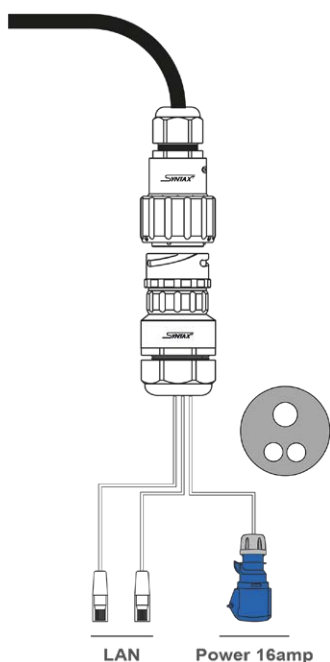

#### Example 1

SGH 8.1 | 3-way Special Grommet  
2 Lan + 3x2.5 (16amp 3p)

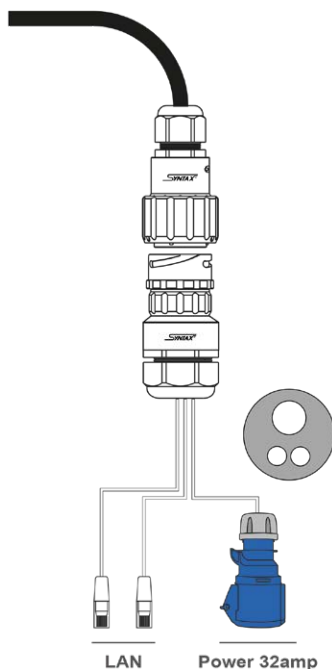

#### Example 2

SGH 8.1 | 3-way Special Grommet  
2 Lan + 3x6 (32amp 3p)

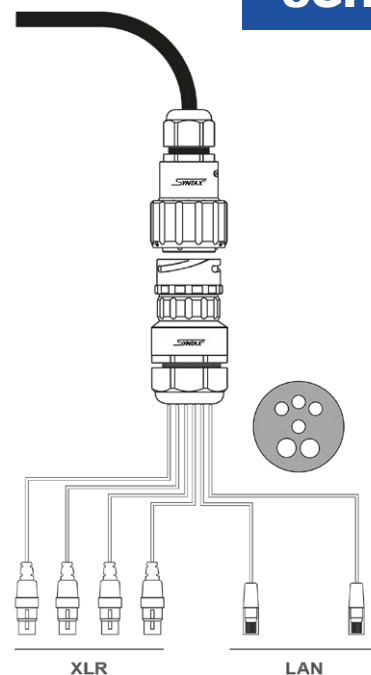

#### Example 3

SGH 8.1 | 6-way Special Grommet  
2 Lan + 4 digit

### SGH 16.1

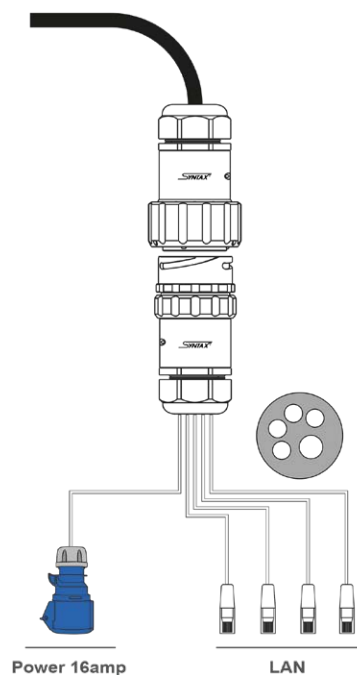

#### Example 1

SGH 16.1 | 5-way Special Grommet  
4 Lan + 3x2.5 (16amp 3p)

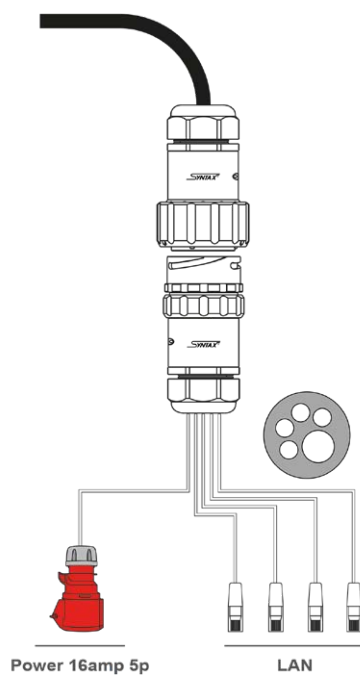

#### Example 2

SGH 16.1 | 5-way Special Grommet  
4 Lan + 5x2.5 (16amp 5p)

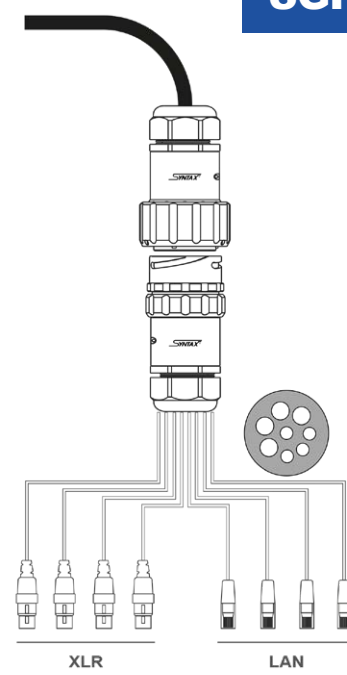

#### Example 3

SGH 16.1 | 8-way Special Grommet  
4 Lan + 4 digit

## Overall dimensions SGH 8.1 Inline and panel versions

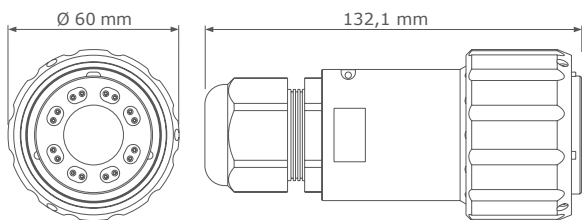

**Inline female**

SGH 8.1 | M32 cable gland for single cable

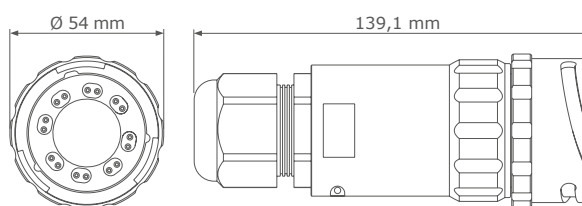

**Inline male**

SGH 8.1 | M32 cable gland for single cable

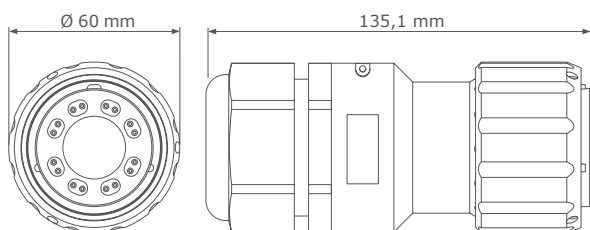

**Inline female - Multiway**

SGH 8.1 | M40 cable gland with multiway grommet for cable splitters

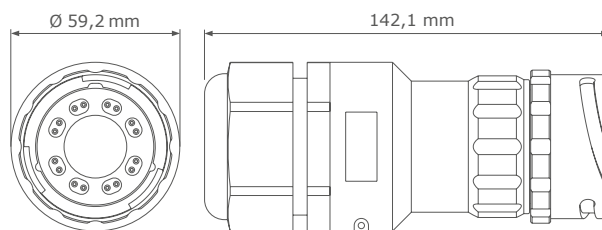

**Inline male - Multiway**

SGH 8.1 | M40 cable gland with multiway grommet for cable splitters

## Special grommets

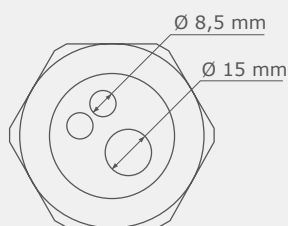

**3-way**

Special Grommet

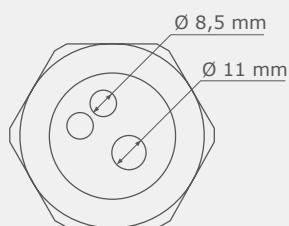

**3-way**

Special Grommet

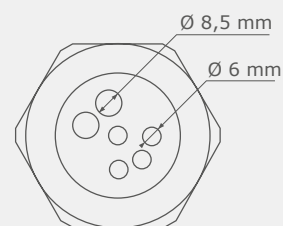

**6-way**

Special Grommet

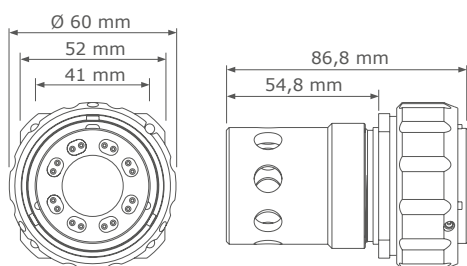

**Panel female**

SGH 8.1 | with perforated backshell

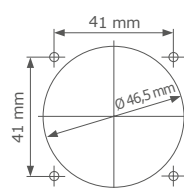

**Cut-out dimensions**

SGH 8.1

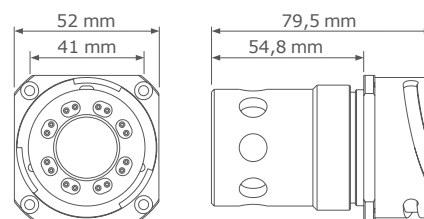

**Panel male**

SGH 8.1 | with perforated backshell

## Overall dimensions

### SGH 16.1 Inline and panel version

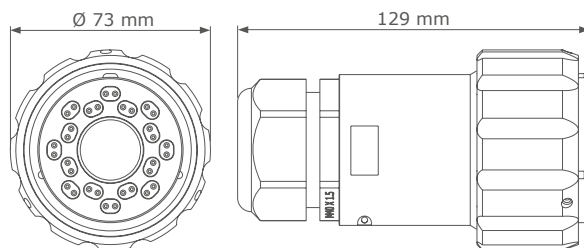

#### Inline and Multiway female

SGH 16.1 | M40 cable gland with standard backshell

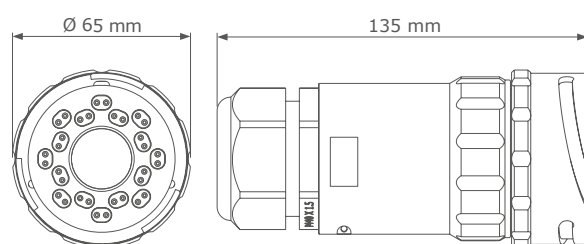

#### Inline and Multiway male

SGH 16.1 | M40 cable gland with standard backshell

## Special grommets

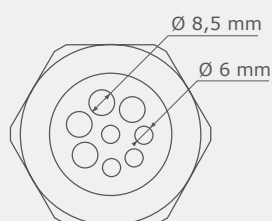

**8-way**  
Special Grommet

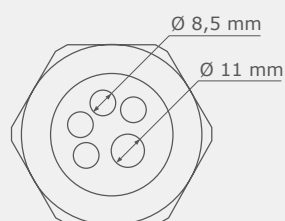

**5-way**  
Special Grommet

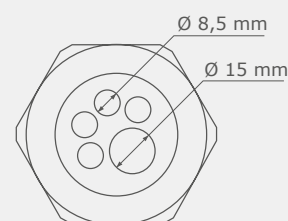

**5-way**  
Special Grommet

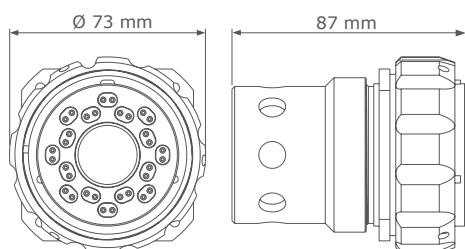

**Panel female**  
SGH 16.1 | with perforated backshell

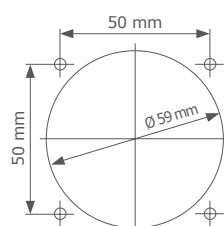

**Cut-out dimensions**  
SGH 16.1

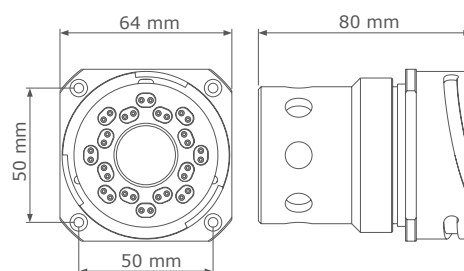

**Panel male**  
SGH 16.1 | with perforated backshell





# Moldules & contacts

Limitless possibilities of power  
and signal configurations

The real advantage of a modular connector like our Syntax Gigamod Hybrid series is the power to choose the features you actually need, without settling for a generic product that might not fulfill all your connection needs. Any central inserts, outer signal modules and contacts are compatible with both SGH 8.1 and SGH 16.1.

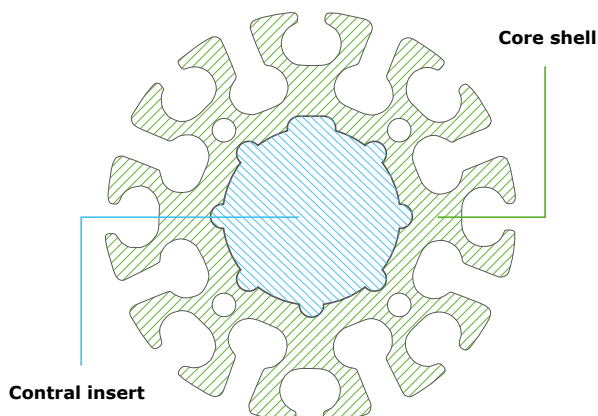

## Modularity

### Core element and modules housing

The **core shell** (for 8 or 16 modules) is a crosstalk-proof section for signals that are particularly sensitive to interference and crosstalk phenomena, such as ethernet lines or digital signals in general. The **central insert** is an electrically insulated section for connections requiring high insulation between contacts, such as main power, speaker lines or analog audio signals.

*SGH 16-module connector shown in the picture on the left.*

## Signal central inserts for additional analog or digital signals

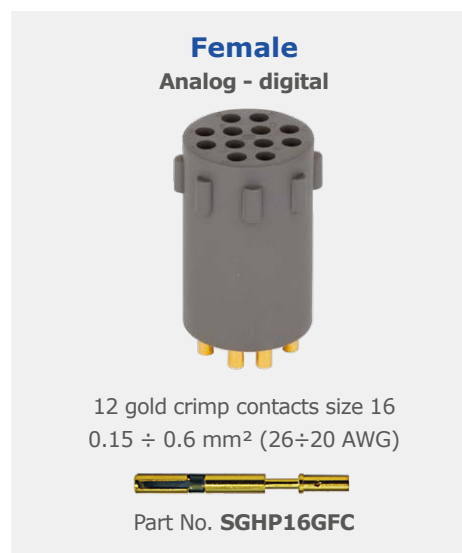

## High conductivity alloy machined contacts for signal central insert

<b>Contact size</b>	16	<b>Section</b>	0.15÷0.6 mm <sup>2</sup> / 26÷20 AWG
<b>Max current</b>	22 Amp	<b>Rated current</b>	13 Amps
<b>Potential drop</b>	74 mV		
<b>Dielectric Strength</b>	4.5 KV	<b>Voltage rating</b>	< 50 Vrms

Contact male Part No. **SGHP16GMC** - Contact female Part No. **SGHP16GFC**

## Blank insert

### Male and Female | Insulating insert

Reversible, fits both male and female connectors



## Power central inserts

Supplied with power contacts (pre-installed) and Capsulock

**Male**  
3p+N+E (4p 5w)



Capsulock  
2.5 mm<sup>2</sup> / 12 AWG power contacts



Capsulock Part No. **SGHCL11**

**Female**  
3p+N+E (4p 5w)



Capsulock  
2.5 mm<sup>2</sup> / 12 AWG power contacts



Capsulock Part No. **SGHCL11**

**Male**  
2p+E (2p 3w)



Capsulock  
2.5 mm<sup>2</sup> / 12 AWG power contacts



Capsulock Part No. **SGHCL11**

**Female**  
2p+E (2p 3w)



Capsulock  
2.5 mm<sup>2</sup> / 12 AWG power contacts



Capsulock Part No. **SGHCL11**

**Male**  
2p+E (2p 3w)



Capsulock  
6 mm<sup>2</sup> / 10 AWG power contacts



Capsulock Part No. **SGHCL10**

**Female**  
2p+E (2p 3w)



Capsulock  
6 mm<sup>2</sup> / 10 AWG power contacts



Capsulock Part No. **SGHCL10**

# High conductivity alloy machined contacts for power central inserts

## Contact size 11

Power 3p+N+E (4p 5w) - Power 2p+E (2p 3w)

<b>Contact size</b>	11	<b>Section</b>	2.5 mm <sup>2</sup> / 12 AWG
<b>Potential drop</b>	63 mV		
<b>Voltage rating AC</b>	700 V	<b>Voltage rating DC</b>	500 V
<b>Max current</b>	41 Amp	<b>Rated current</b>	23 Amp
<b>Min. Flashover</b>	2800 Vac RMS	<b>Test voltage</b>	2000 Vac RMS

Contact male Part No. **SGHP11GMC** - Contact female Part No. **SGHP11GFC**

## Contact size 10

Power 2p+E (2p 3w)

<b>Contact size</b>	10	<b>Section</b>	6 mm <sup>2</sup> / 10 AWG
<b>Potential drop</b>	65 mV		
<b>Voltage rating AC</b>	700 V	<b>Voltage rating DC</b>	500 V
<b>Max current</b>	73 Amp	<b>Rated current</b>	46 Amp
<b>Min. Flashover</b>	2800 Vac RMS	<b>Test voltage</b>	2000 Vac RMS

Contact male Part No. **SGHP10SMS** - Contact female Part No. **SGHP10SFS**

## Capsulock power contacts

### Anti-shortcircuit loose wire proof safety power contacts

The Syntax Capsulock power contacts are a proprietary insulation system ensuring electrical safety on the connections inside the SGH, even in case of exceptional events. This solution provides electrical insulation, making that each power contact is individually insulated from other contacts and from the shell.

The insulation system of the Capsulock is made up of two coupling thermoplastic half-capsules that are snapped together and encapsulate the area with the crimped contact-to-cable connections, thus sealing the electrical leads and preventing the live wires from touching each other or getting in contact with the metal parts of the connector. Even in the unlikely event of a violent pull of the cable, the two halves provide complete protection against short circuits.



#### 2.5 mm<sup>2</sup> / 12 AWG

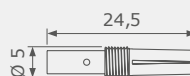

**Electric ferrule**  
Dimensions in mm

#### 6 mm<sup>2</sup> / 10 AWG



**Electric ferrule**  
Dimensions in mm



**Front and Rear half-capsules**  
Dimensions in mm



**Front and Rear half-capsules**  
Dimensions in mm



**Assembled Capsulock**  
Dimensions in mm



**Assembled Capsulock**  
Dimensions in mm

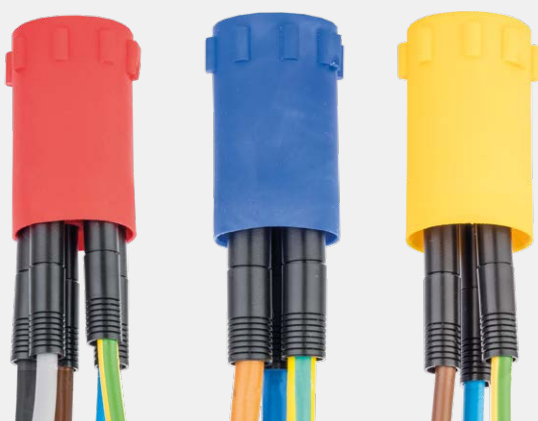





## Tunnel modules

The insulated modules fitted in the Syntax Safe Tunnels hold a pair of signal contacts and are color coded deriving from EIA / TIA standard (for Ethernet) or black (for other kinds of signals).

On the SGH series, two shell sizes are available. The smaller shell is for SGH 8.1 versions, and holds 8 modules + 1 central insert.

The bigger shell is for SGH 16.1 versions, and holds 16 modules + 1 central insert.



**Male**  
module for Syntax Safe Tunnel



Part No. **SGHP20GMC**

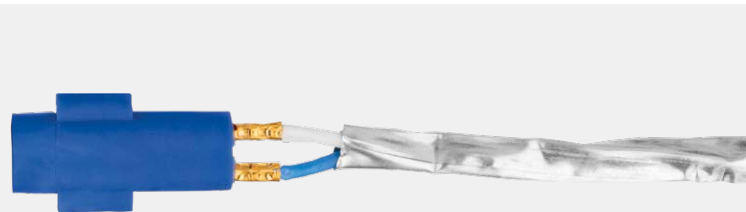

**Female**  
module for Syntax Safe Tunnel



Part No. **SGHP20GFC**

## High conductivity alloy machined contacts for tunnel modules

<b>Contact size</b>	20	<b>Section</b>	0.15÷0.3 mm <sup>2</sup> / 26÷22 AWG
<b>Max current</b>	10 Amp	<b>Rated current</b>	7.5 Amp
<b>Potential drop</b>	83 mV		
<b>Dielectric Strength</b>	4.2 KV	<b>Voltage rating</b>	< 50 Vms

Contact male Part No. **SGHP20GMC** - Contact female Part No. **SGHP20GFC**





# Syntax Wireasy technology

SGH is designed to be quick to wire

We know your time is valuable. That's why our SGH series is based on Syntax Wireasy Technology, with special focus on assembling and wiring simplicity. Forget those complex, time-consuming procedures needed for other hybrid connectors. Our SGH has been designed for lightning-fast wiring and supereasy assembly. Watch the tutorials or download the manuals on the website for more details.

Wire your circular hybrid connector in just a few steps.

**Syntax Wireasy Technology** will make your work easier, with user-friendly assembly and no time wasted for the wiring operations. Wireasy allows for superfast maintenance or assembly even on the job, as no special tools are needed.



## Wiring diagram SGH 8.1 and SGH 16.1

modules and inserts - back view



**SGH 16.1 female**  
Wiring diagram

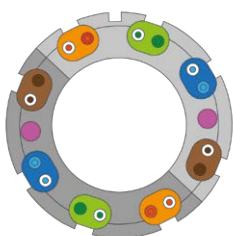

**SGH 8.1 female**  
Wiring diagram



**SGH 16.1 male**  
Wiring diagram

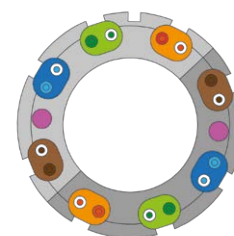

**SGH 8.1 male**  
Wiring diagram

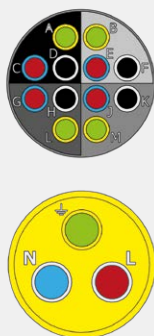

Ch	Ground	Hot	Cold
1	B	E	F
2	M	J	K
3	L	G	H
4	A	C	D



**Central insert female**  
Wiring diagram SGH 8.1 | SGH 16.1

**Central insert male**  
Wiring diagram SGH 8.1 | SGH 16.1





# Cable protection and management

Wire mesh strain relief, hanger grip and pulling grip

Explore our full range of wire mesh cable management solutions for our Syntax connectors, designed to ease optimal cable laying and organization and to provide protection from excessive bending due to gravity or any unwanted external force, in order to sensibly increase the life span of your connections.



# Wire mesh strain relief

## Preserve the integrity of your connections

These cable grips, sometimes referred to as “basket weave”, are made up of a woven steel wire mesh and a watertight gland nut. This strain relief system is designed to be anti-bending, offering the following key benefits:

- Impossible to pull out the cable from the strain relief through lateral force; the more the cable is pulled the tighter the grip becomes.
- Prevents any damage that might be caused by flexing the cable. Such a grip design is suited for large diameter cables which require a better protection of the internal conductors.

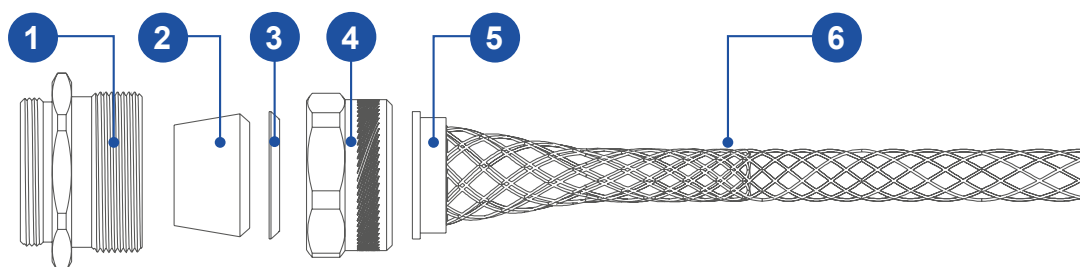

1. Threaded body | 2. Grommet | 3. Friction ring | 4. Compression nut | 5. Rings | 6. Wire mesh

Part No. Strain Relief	Threaded size	Cable range	Compatible Syntax Cables
<b>7ZK32A191B224</b>	M 32 x 1.5	Ø 19.1 to 22.4 mm (.75" to .88")	<ul style="list-style-type: none"> <li>• 2CAT6A   Ø 20 mm   Part No. <b>7XLAN2CAT6AUF</b></li> <li>• 2 x CAT6A + 3G2.5 mm<sup>2</sup>   Ø 21 mm   Part No. <b>7YLN2CAT6APW325G</b></li> <li>• 2 x CAT6A + 5G2.5 mm<sup>2</sup>   Ø 20 mm   Part No. <b>7YLN2CAT6APW525</b></li> <li>• 2 x CAT6A + 3G6 mm<sup>2</sup>   Ø 20 mm   Part No. <b>7YLN2CAT6APW360</b></li> <li>• 2 x CAT6A + 4 digital   Ø 20 mm   Part No. <b>7YLN2CAT6ADG4</b></li> </ul>
<b>7ZK40A191B224</b>	M 40 x 1.5	Ø 19.1 to 22.4 mm (.75" to .88")	<ul style="list-style-type: none"> <li>• 2CAT6A   Ø 20 mm   Part No. <b>7XLAN2CAT6AUF</b></li> <li>• 2 x CAT6A + 3G2.5 mm<sup>2</sup>   Ø 21 mm   Part No. <b>7YLN2CAT6APW325G</b></li> <li>• 2 x CAT6A + 5G2.5 mm<sup>2</sup>   Ø 20 mm   Part No. <b>7YLN2CAT6APW525</b></li> <li>• 2 x CAT6A + 3G6 mm<sup>2</sup>   Ø 20 mm   Part No. <b>7YLN2CAT6APW360</b></li> <li>• 2 x CAT6A + 4 digital   Ø 20 mm   Part No. <b>7YLN2CAT6ADG4</b></li> </ul>
<b>7ZK40A224B254</b>	M 40 x 1.5	Ø 22.4 to 25.4 mm (.88" to 1.00")	<ul style="list-style-type: none"> <li>• 4 x CAT6A   Ø 23.5 mm   Part No. <b>7XLAN4CAT6AUF</b></li> <li>• 4 x CAT6A + 5G2.5 mm<sup>2</sup>   Ø 23.5 mm   Part No. <b>7YLN4CAT6APW525</b></li> <li>• 4 x CAT6A + 3G6 mm<sup>2</sup>   Ø 25 mm   Part No. <b>7YLN4CAT6APW360</b></li> <li>• 4 CAT6A + 4 digital   Ø 24 mm   Part No. <b>7YLN4CAT6ADG4</b></li> </ul>

Other models available. Contact us for more information.





## The right technology for long-lasting connections

### Discover our cable management solutions

The quality of a connection depends on many factors. Reliable connectors are essential, of course, and the cables are a top priority too. Choosing high quality products made with the best materials is important, but there are other parts of the job that should not be overlooked. How you lay a cable, how you protect it from unwanted stresses, how you make sure it will be safeguarded from external elements that might possibly damage your connections over time, these decisions are all integral to achieving highly reliable connections.

Our accessories are thoughtfully designed and manufactured for ideal cable management, handling and protection.

**Please contact us for more information about our cable management accessories.**

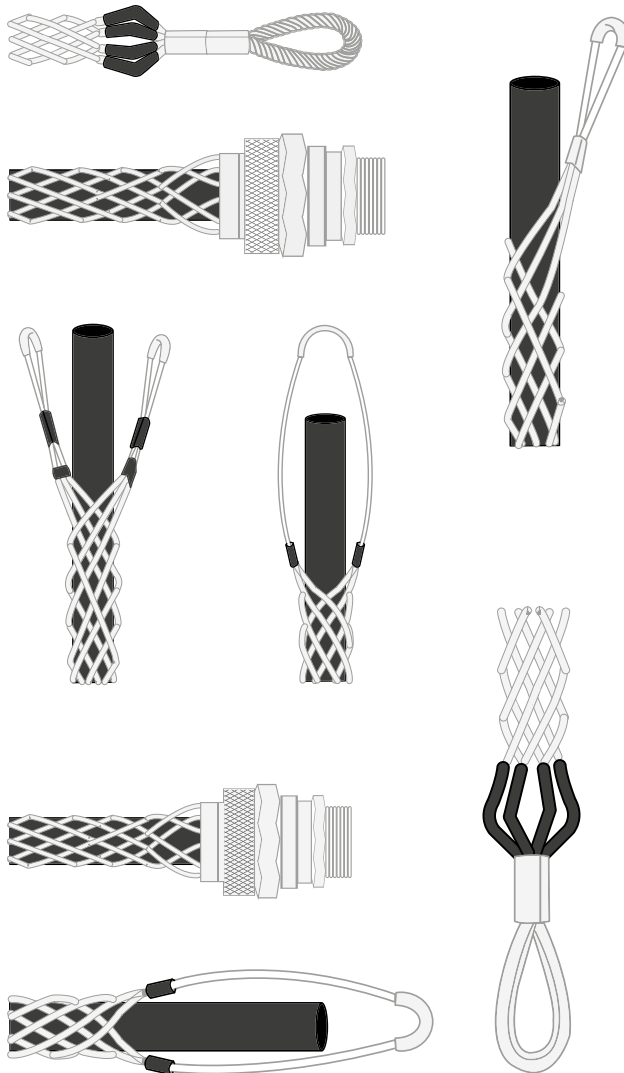

### Strain Reliefs

Thoughtfully designed to reduce tension on cables and, therefore, stress related damages to your connections due to excessive bending. Available in a wide range of thread sizes and overall diameters to fit any connector and cable combinations.

### Hanger grips

Heavy duty wire mesh hangers are designed to ensure optimal support and right retention of the cable without any sliding or scraping of the external jacket. Different styles and sizes are available in stock for any kind of application, both indoors or outdoors.

### Pulling grips

Created to provide the operators an efficient way to pull cables through ducts or other spaces in the safest possible way. Made to be extremely resistant and conveniently reusable, and fit to a large number of applications. Different models available.

## Metric cable glands

Metric thread cable glands allow more versatility compared to PG or other thread types. All cable glands supplied with the Syntax Gigamod Hybrid connectors provide IP68 rating at the back of the connectors.

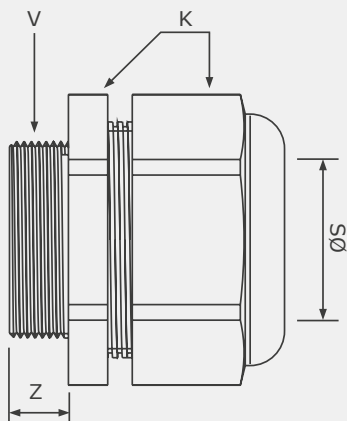

## Cable Clamp - Metric

Thread size (V)	Clamping range (Ø S)	Spanner size (K)	Length of thread (Z)
M32 (for SGH 8.1 inline)	18 - 25 mm	SW 42	10 mm
M40 (for SGH 16.1 inline)	19 - 28 mm	SW 46	12 mm
M40 Oversized (for SGH 8.1 multiway and SGH 16.1 inline and multiway)	22 - 32 mm	SW 53	13 mm

MEP 1-4

MEP 5-8

MEP 9-12

MEP 13-16



## The IP67 caps are supplied as a standard



### Waterproof your connectors

IP67 protection of the Syntax Gigamod Hybrid is fully ensured when all the connectors are mated or all the caps are fitted.



IP67 cap for male SGH connector



IP67 cap for female SGH connector





# Syntax® SGH possible use cases

The versatility of a true hybrid  
and modular connector

Imagine the countless applications of a multimodule circular connector for Ethernet, HDMI, USB signals also carrying a central module for power or additional signals. Thanks to its modular circular design, Syntax Gigamod Hybrid provides an almost limitless range of applications, i.e. occasions for you to make it a tool for optimal connections and cables management. Take advantage of so many combinations being available and choose the one just perfect for your needs. Here are a few examples.

# SGH 16.1 - Possible use case 1

**SGH 16.1 | 2 Lan - 32amp - HDMI**  
**Ethernet, multimedia and power distribution**

16 contact modules + 1 insert 32 amp 2p+E (2p 3w)

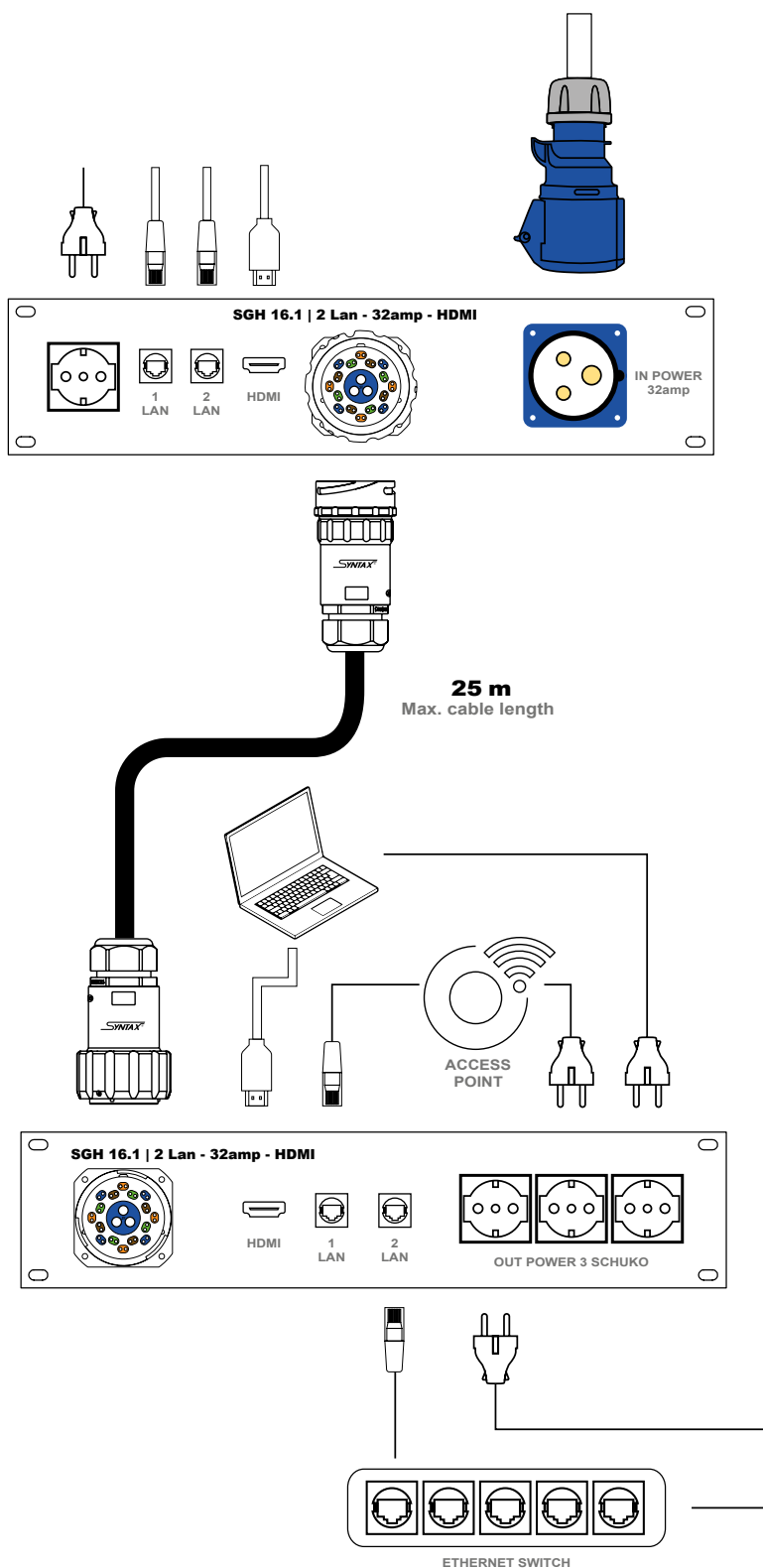

**SGH 16.1**



# SGH 16.1 - Possible use case 2

## SGH 16.1 | 4 Lan - 16amp 5p Ethernet and 3P+N+E power distribution

16 contact modules + 1 insert 16 amp 3p+N+E (4p 5w)



### SGH 16.1

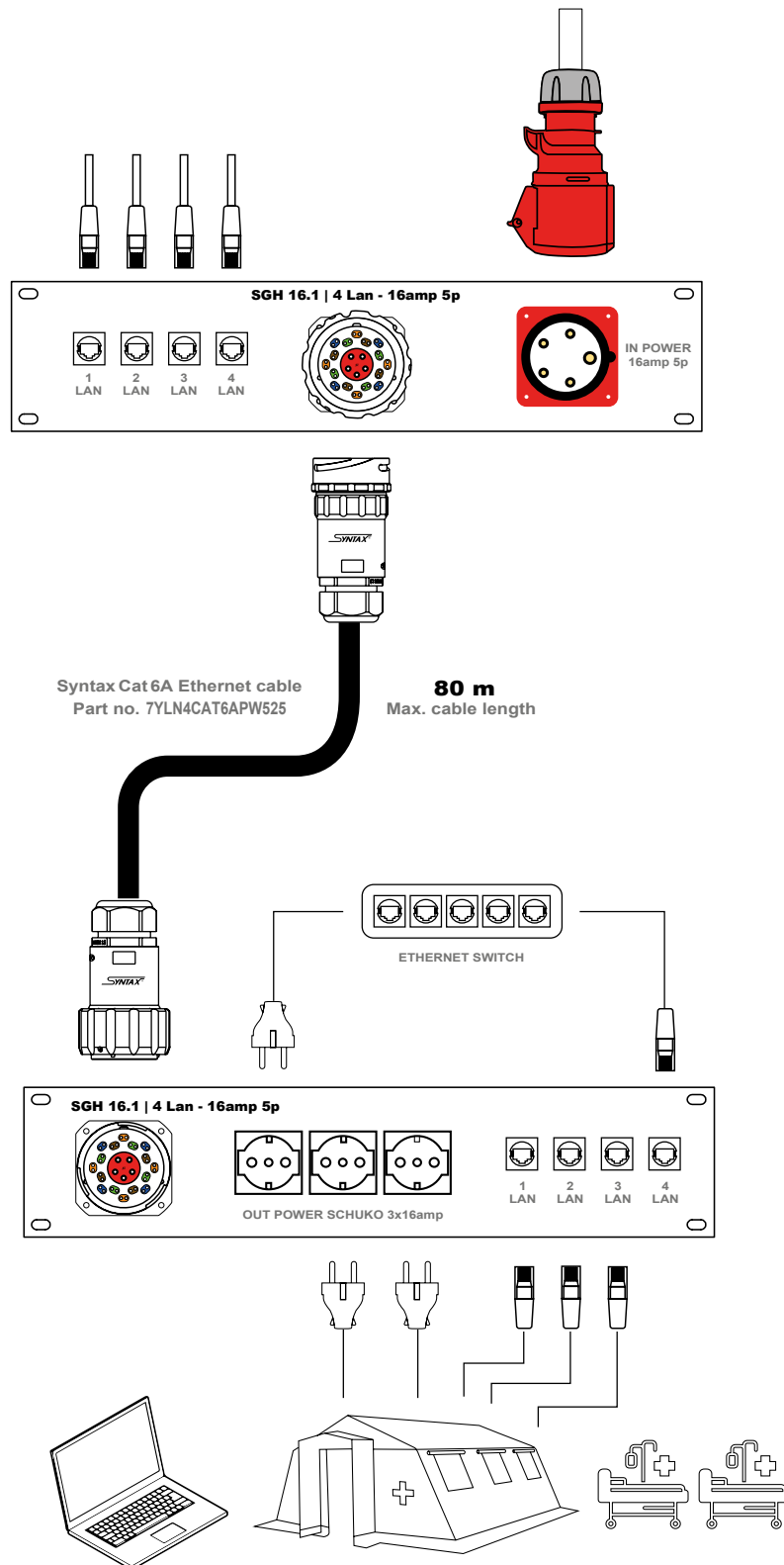

# SGH 16.1 - Possible use case 3

## SGH 16.1 | 4 Lan - 4 balanced signals Ethernet and Live Show Devices

16 contact modules + 1 insert analog - digital

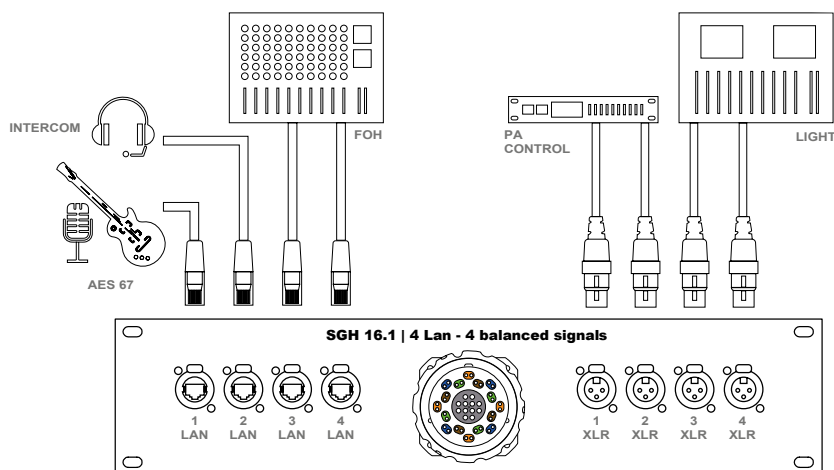

Syntax Cat6A Ethernet cable  
Part no. 7YLN4CAT6ADG4

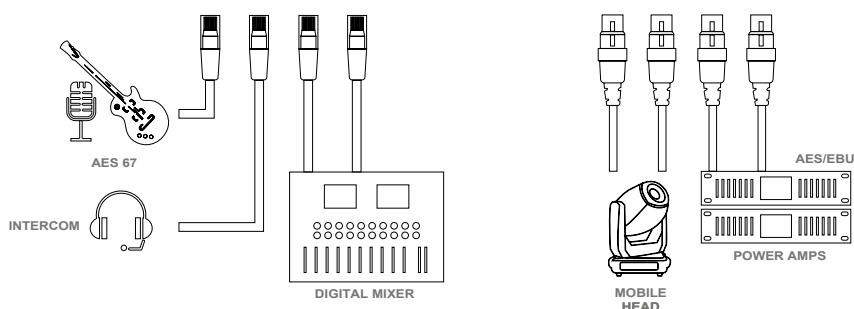
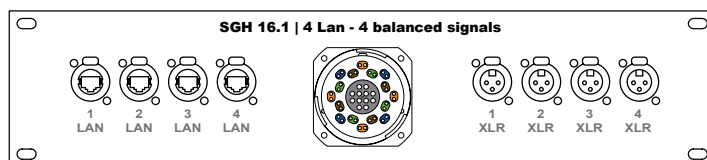
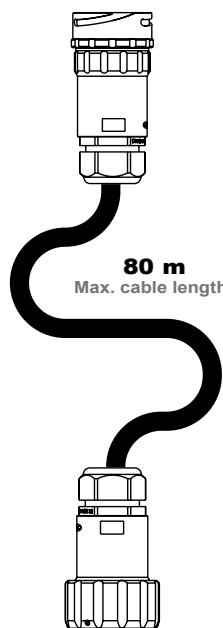

## SGH 16.1





# SGH 16.1 - Possible use case 4

## SGH 16.1 | 1 Lan - Digital - 32amp Ethernet, Digital and Power distribution

16 contact modules + 1 insert 32 amp 2p+E (2p 3w)



**SGH 16.1**

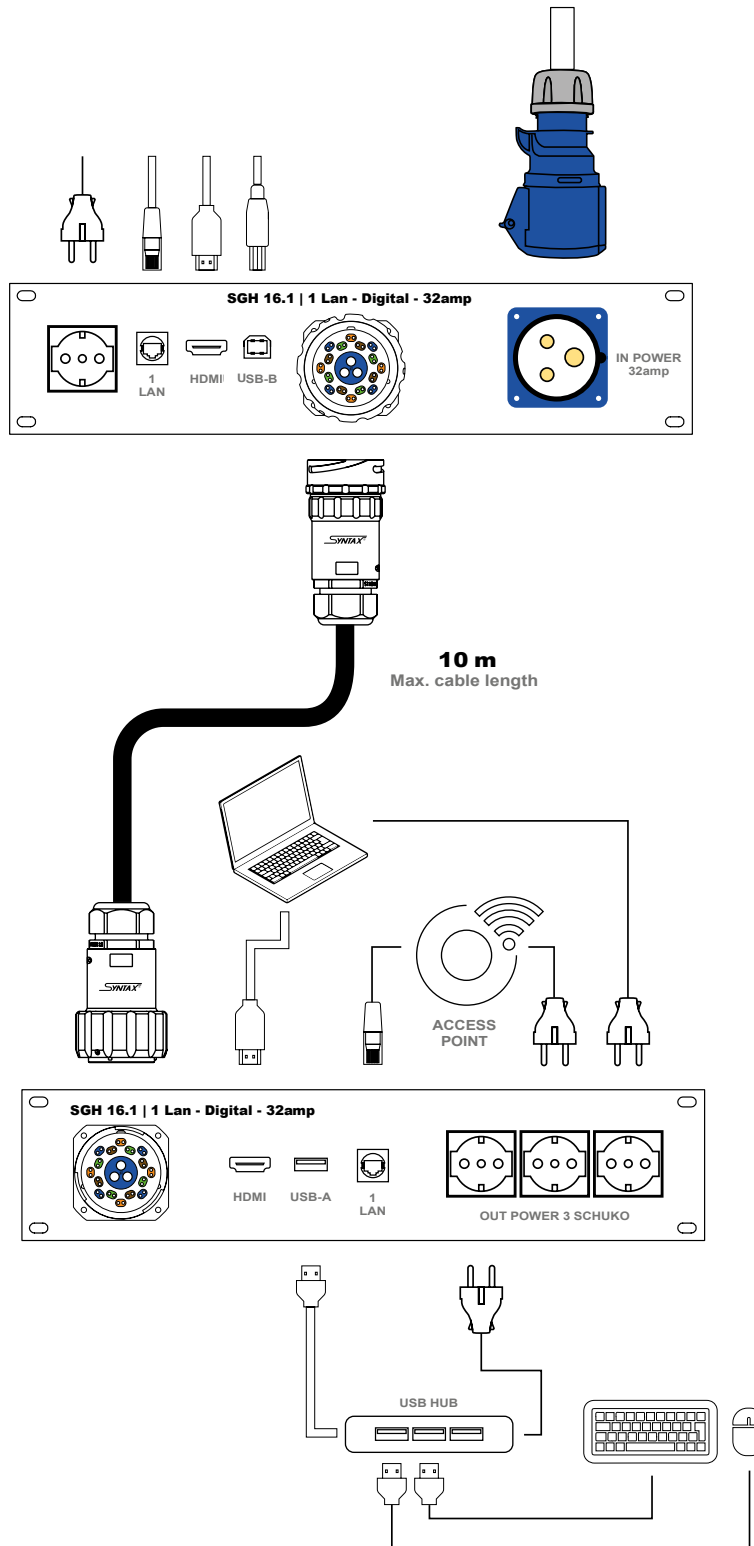

# SGH 16.1 - Possible use case 5

## SGH 16.1 | 4 Lan - 32amp Ethernet and Power distribution

16 contact modules + 1 insert 32 amp 2p+E (2p 3w)

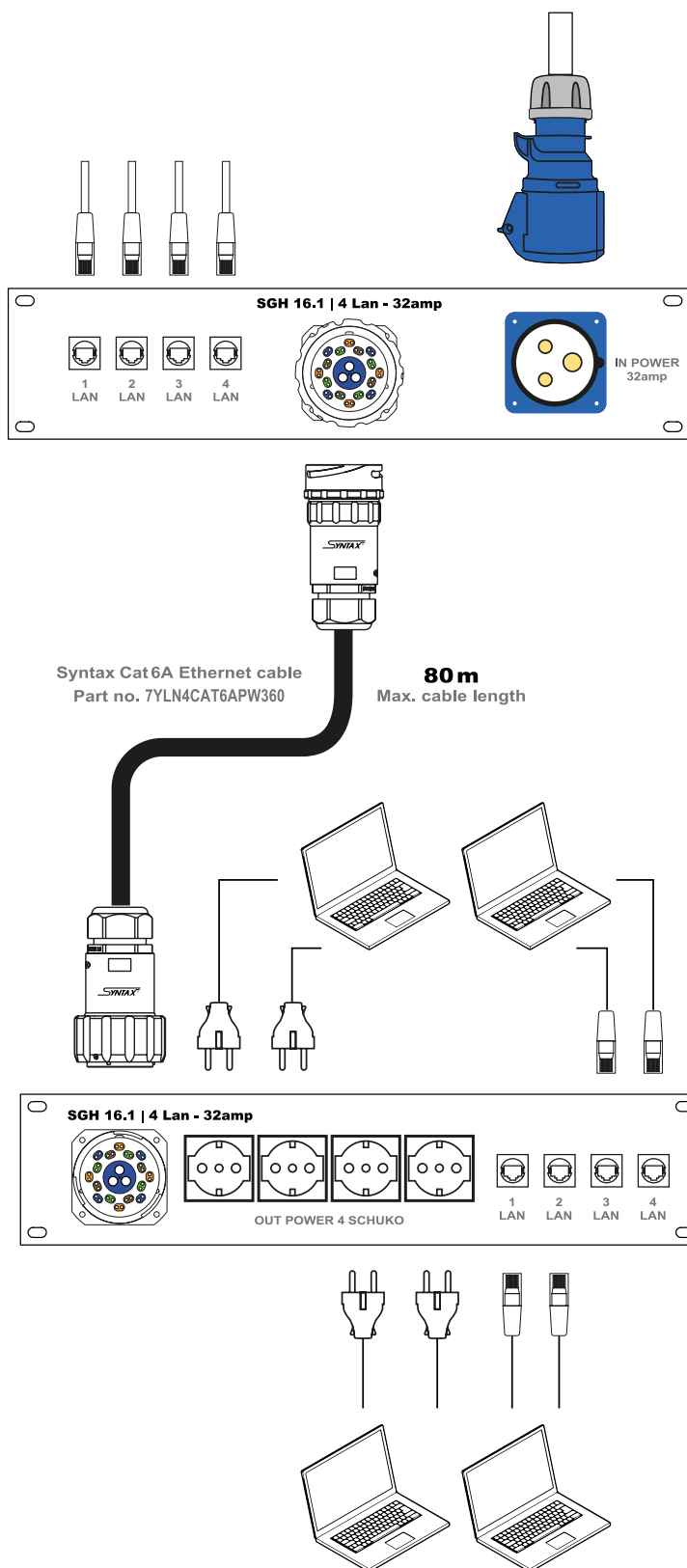

## SGH 16.1



# SGH 8.1 - Possible use case 1

## SGH 8.1 | 2 Lan - 16amp Ethernet and Power distribution

8 contact modules + 1 insert 16 amp 2p+E (2p 3w)



### SGH 8.1

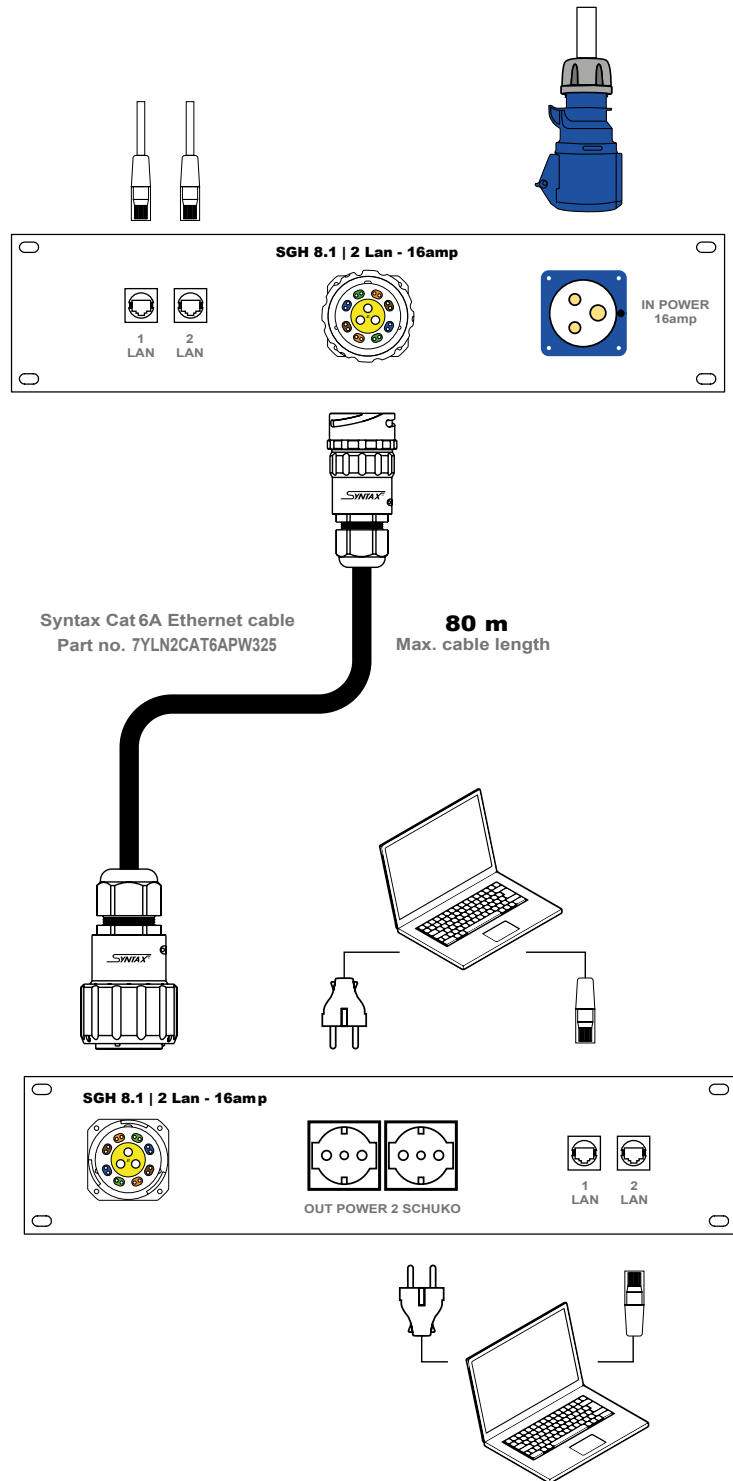

# SGH 8.1 - Possible use case 2

## SGH 8.1 | 2 Lan - 4 balanced signals Ethernet and Live Show Devices

8 contact modules + 1 insert analog - digital

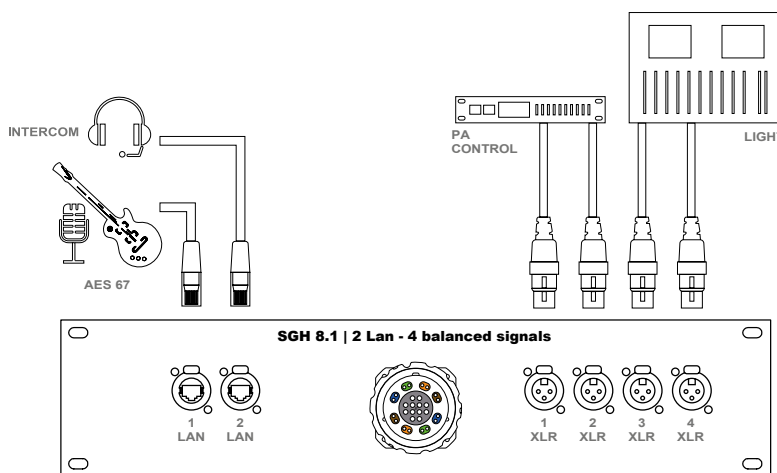

Syntax Cat 6A Ethernet cable  
Part no. 7YLN4CAT6ADG4

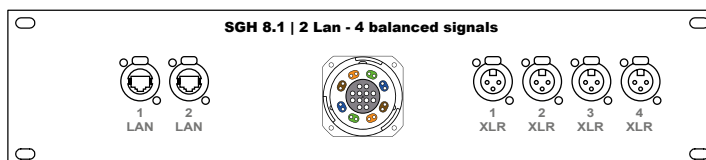
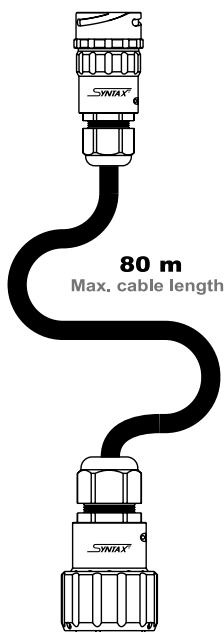

## SGH 8.1





# SGH 8.1 - Possible use case 3

SGH 8.1 | 1 Lan - 4 shielded signals - 12 GPIO  
Monitoring and control system

8 contact modules + 1 insert analog - digital

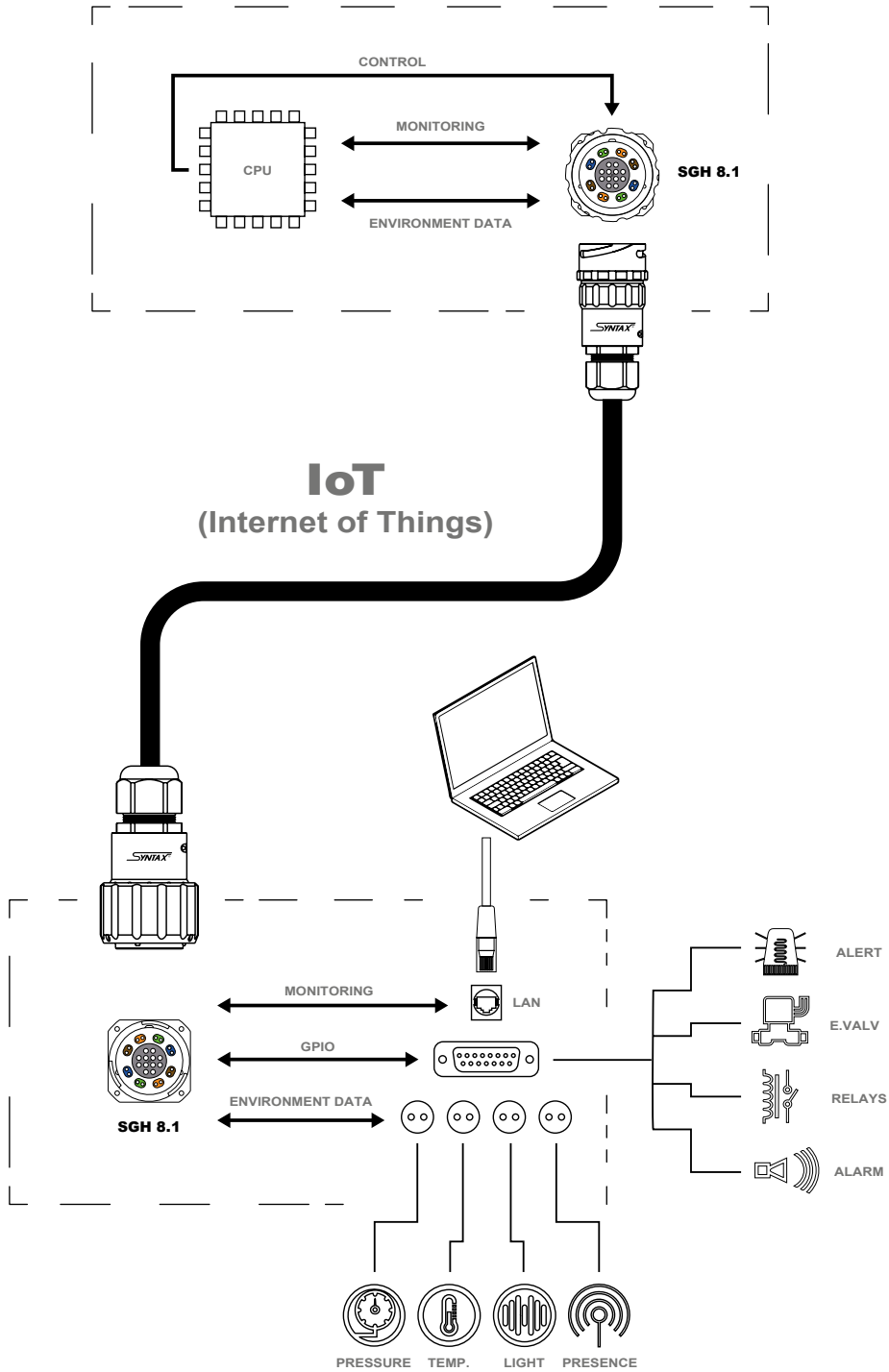

**SGH 8.1**

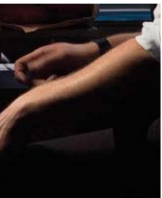

# SGH 8.1 - Possible use case 4

SGH 8.1 | 1 Lan - 4 shielded signals  
Ethernet and monitoring system

8 contact modules + 1 blank insert

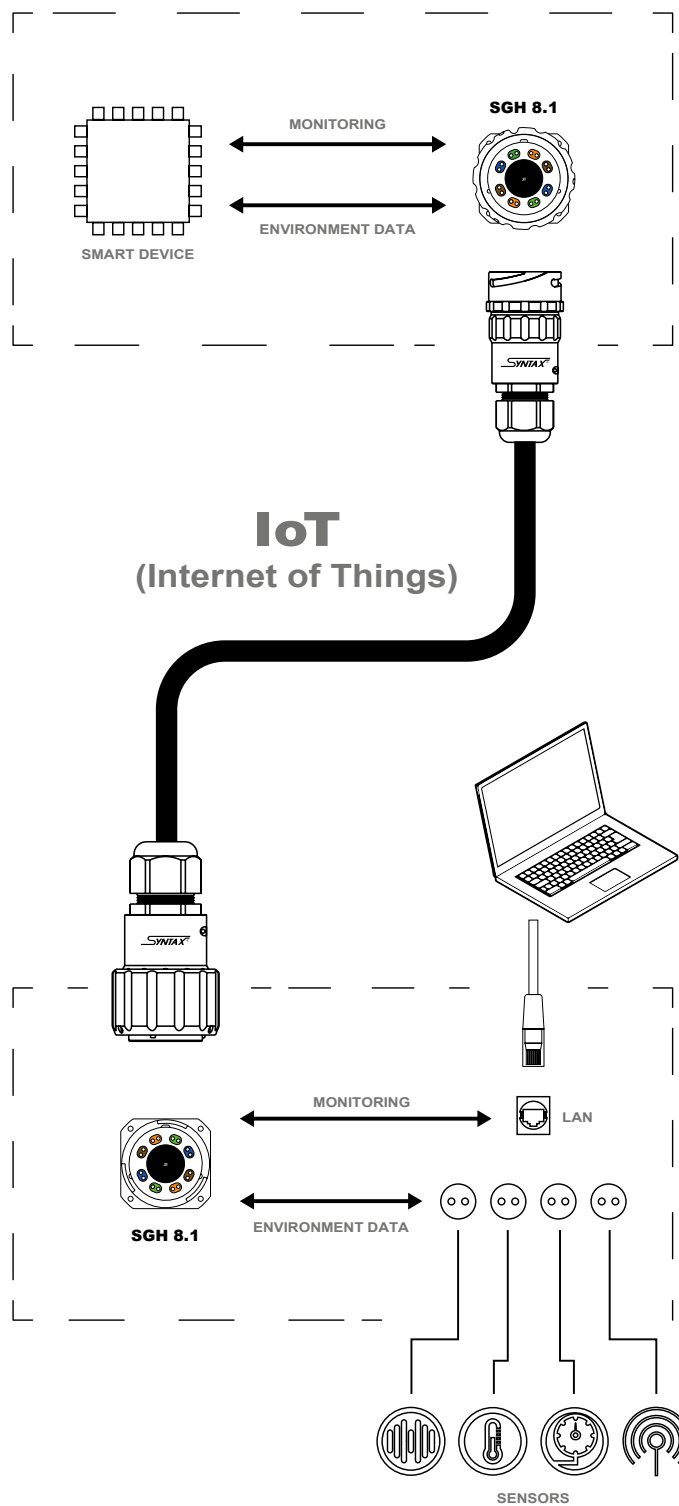

**SGH 8.1**



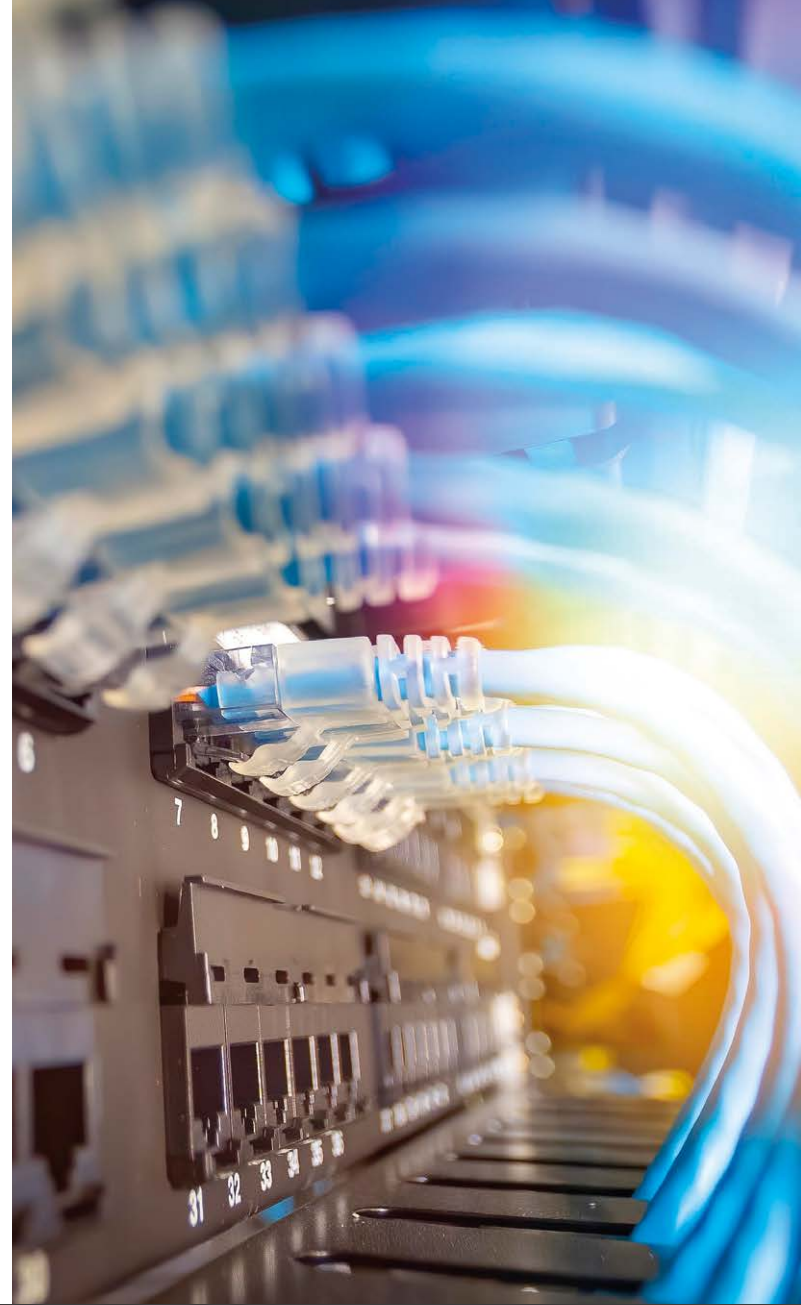

# Found your connector? Now pick the cable!

Cables for SGH connectors series

Flexible, easy to handle, all in one professional cables for almost limitless applications. Robust and super easy for fast wiring.

**Syntax Hybrid Cables with 2 x Ethernet**  
**Syntax Hybrid Cables with 4 x Ethernet**  
**Syntax Breakout Cables**

# Syntax Cables with 2 x Ethernet

## for SGH 8.1

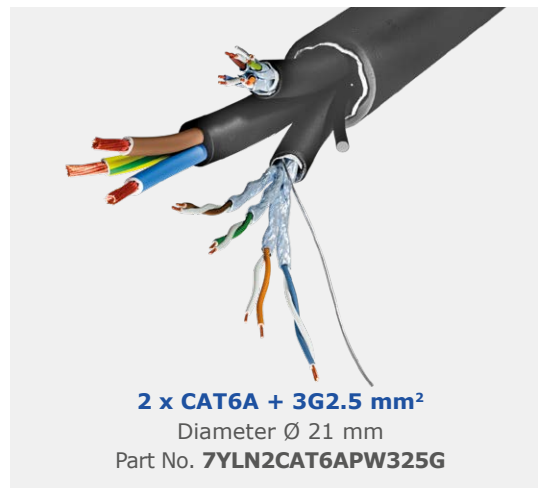
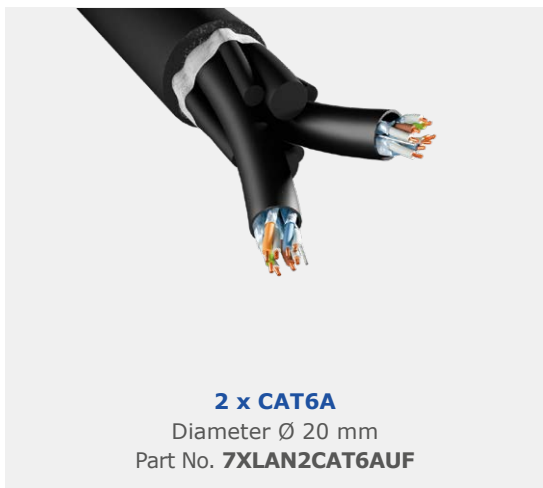



## Syntax Cables with 4 x Ethernet for SGH 16.1

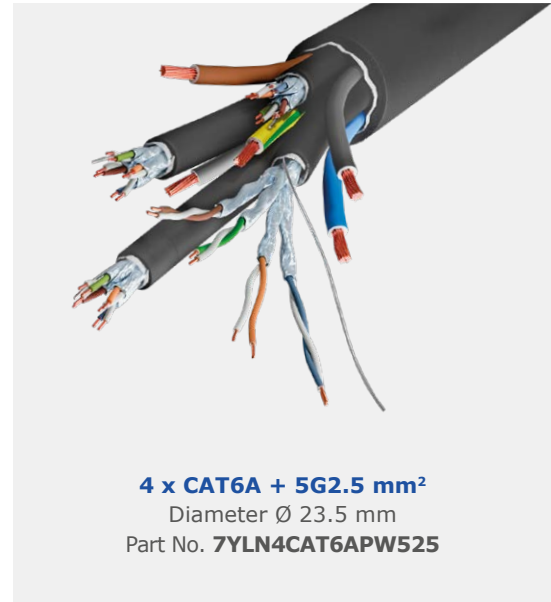
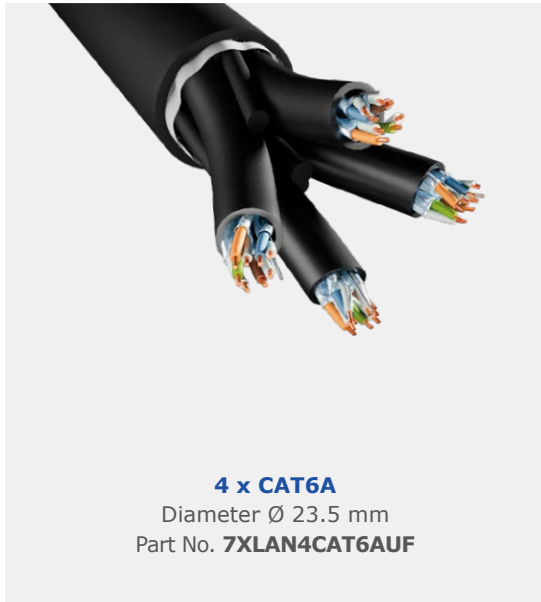

# Syntax Breakout Cables

## for SGH Series

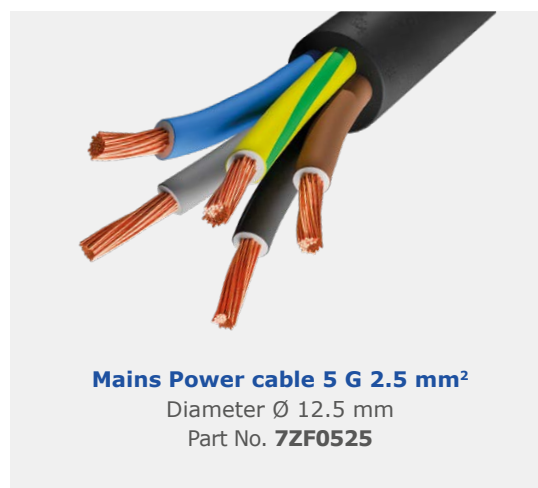
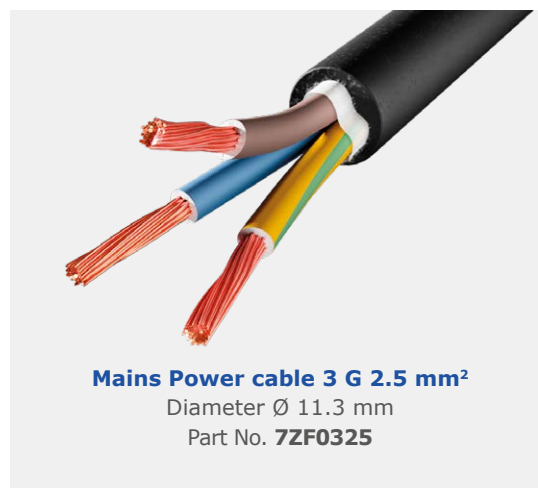
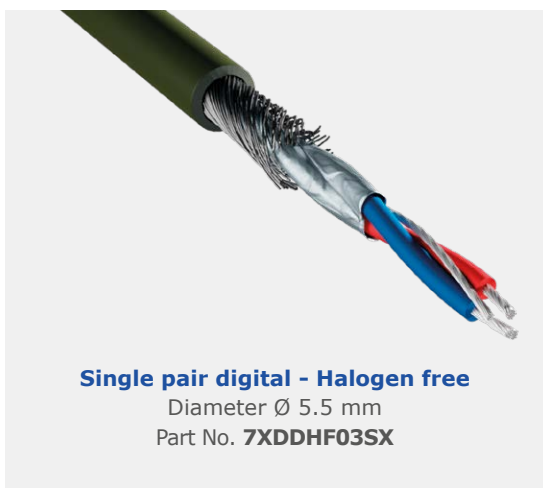
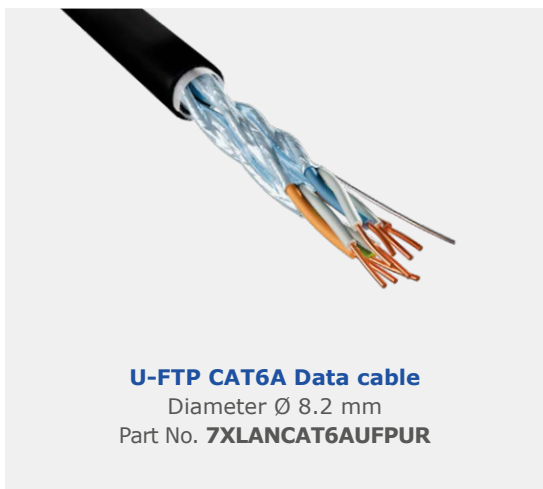

# Syntax® Tools

## Essential to connecting

Tools for crimping, insertion & removal of contacts and tightening tools for Syntax Gigamod Hybrid connectors series.



## SGH Tightening tool

The capsule is placed on the tightening tool with the threaded part facing upwards. The tool allows to fit and tighten the locking ring on the connector's capsule.

Part No. **SGH-TLT**

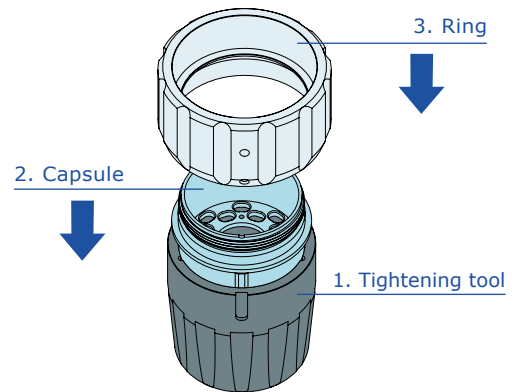

**Data modules housings**



**Core shell housings**

## SGH Tool for modules insertion

A specific tool allows to insert the contacts easily inside the modules. On the tool, there are two housings on the front for DATA/SIGNAL MODULES, and a housing on both the top and the bottom for the central insert and CORE SHELL (one of the housings is for the 8.1 model, the other is for the 16.1 model). For correct usage of the tool, clamp it on a vise.

Part No. **SGH-TLA**

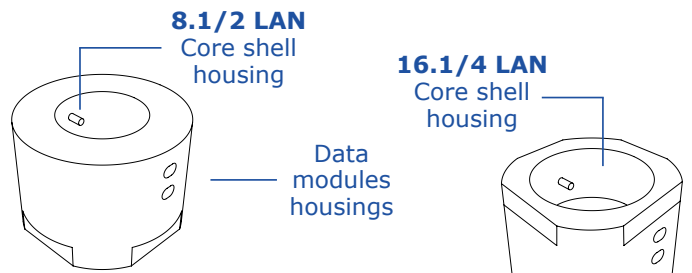

## Guide pins

### for female contacts

Guide pins are used to insert female contacts only. Remove the guide pin from the inserted contact and use it for the next contact.

Part No. **SVKT20GP | SVKT18GP | SVKT16GP | SVKT12GP | SVKT59GP**



## Hydraulic crimping tool 45kN

Lightweight and compact, this tool is ideal to crimp connectors on overhead lines and general electric applications. Thanks to spring loaded handles, you can use the tool and crimp contacts with just one hand, with the other hand free to position the connector. For easier operations, the tool head can be rotated by 180 degrees. The built-in safety valve will bypass the oil supply when the maximum pressure is reached. The pressure release system can be easily operated at any stage of the compression.

Part No. **SBH-CRIMP-A**



## Crimping accessories

\*suitable for SGH Capsulock 32 amp

<b>SBH</b>	ME1*	for cable 4 to 6 mm <sup>2</sup>
<b>SBH</b>	ME2	for cable 10 mm <sup>2</sup>
<b>SBH</b>	ME3	for cable 16 mm <sup>2</sup>
<b>SBH</b>	ME5	for cable 25 mm <sup>2</sup>

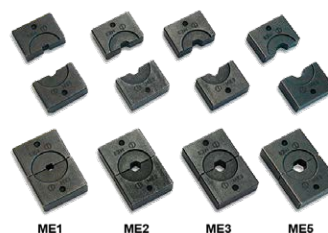

## Manual crimping tool

The manual crimping tool AF8 is compliant with MIL-DTL-22520/1 and AS22520/1 and is suitable for all wire gages from 12 to 26 AWG. The 8-point crimping of the AF8 tool ensures maximum strength and resistance on the crimped connection. Special indent configurations and gaging are available on request.



**Manual crimping tool**  
Part No. **SVKTCRIMP**

For proper operation, the tool must be used with a military standard turret positioner, easily fitted on the crimping tool by orienting the head in the keyed position, and by tightening the hex socket screws supplied. The precision ratchet controls cycling of the tool in both directions of handle movement, ensuring the same accurate crimp every time.



**Turret positioner**  
Part No. **SVKTOR**

Crimp depth is controlled by an 8 position selector knob. The operator will just need to select the setting for the wire being used. The setting can be secured by use of a locking pin or safety wire. Periodic gaging is recommended for accurate calibration. Keep the unit clean and properly stored, no other operator maintenance is required.



## Insertion tools

Insertion tools for male and female contacts (using guide pins is recommended for female contacts).

Part No. **SVKTINS12**  
Part No. **SVKTINS16**  
Part No. **SVKTINS18/20**



## Removal tool

Only use the recommended removal tool to remove a contact or adjust its position in the cavity.

Part No. **SVKTESTR11**  
Part No. **SVKTESTR12**  
Part No. **SVKTESTR16**



## PART NUMBER EXPLANATION

Syntax Gigamod Hybrid

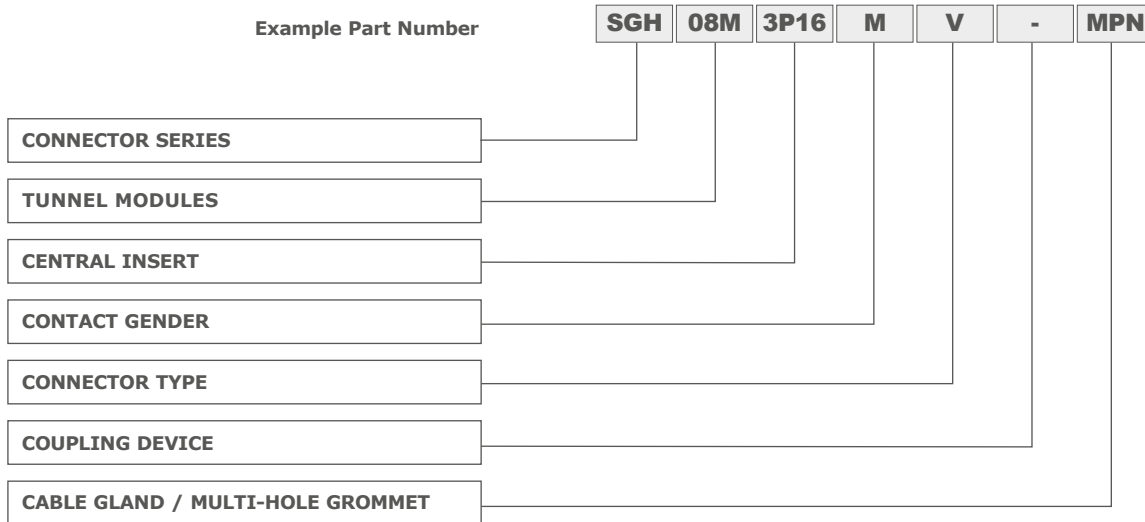

**Notes: all SGH connectors supplied with IP67 protection caps as a standard**

### Connector Series

**SGH** Syntax Gigamod Hybrid

### Number of tunnel modules

**08M** SGH 8.1 version with 8 tunnels  
**16M** SGH 16.1 version with 16 tunnels

### Central insert for 8.1 and 16.1

supplied with power contacts (pre-inserted) and capsulock

**3P16** 2P+E 2.5mm<sup>2</sup>/AWG12 (yellow)  
**5P16** 3P+N+E 2.5mm<sup>2</sup>/AWG12 (red)  
**3P32** 2P+E 6mm<sup>2</sup>/ AWG10 (blue)

### signal contacts

**12GC** 12 gold crimp contacts size 16  
 (0.15÷0.6mm<sup>2</sup> / AWG26÷20) - (grey)

### blank insert

**0000** Blank (black)

### Contact gender

**M** Male  
**F** Female

### Connector type

**V** Inline  
**P** Panel (complete with perforated backshell)

### Coupling device

- Bayonet lock ramps on male  
**D** Heavy duty locking ring on female

### Cable gland / Multi-hole grommet

#### Cable gland

**MON** Thread size: **M32x1.5** - for **SGH 8.1**  
 Clamping range (mm): 18-25

compatible with the following

[Syntax Hybrid Cables \(for SGH 8.1\):](#)

- 7XLN2LANCAT6AUF
- 7YLN2LANCAT6APW325G
- 7YLN2LANCAT6APW525
- 7YLN2LANCAT6APW360
- 7YLN2LANCAT6ADG4

**MPN** Thread size: **M40x1.5** - for **SGH 16.1**

compatible with the following

[Syntax Hybrid Cables \(for SGH 16.1\):](#)

- 7XLN4LANCAT6AUF
- 7YLN4LANCAT6APW525
- 7YLN4LANCAT6APW360
- 7YLN4LANCAT6ADG4

#### Multi-hole grommet

backshell thread size: **M40x1.5**

- M3A** Special grommet 3-way (2 Lan + 3x2.5) for SGH 8.1
- M3B** Special grommet 3-way (2 Lan + 3x6 or 5x2.5) for SGH 8.1
- M5A** Special grommet 5-way (4 Lan + 3x2.5) for SGH 16.1
- M5B** Special grommet 5-way (4 Lan + 3x6 or 5x2.5) for SGH 16.1
- M6D** Special grommet 6-way (2 Lan + 4 digit) for SGH 8.1
- M8D** Special grommet 8-way (4 Lan + 4 digit) for SGH 16.1

## PART NUMBER EXPLANATION

Syntax Gigamod Hybrid

### Tunnel modules & contacts pack

Choose pack and order to complete SGH connector		
	<p><b>SGHMC20MM-PK04 Tunnel Modules</b> Pack with 4 EIA/TIA color-coded ethernet male modules + 10 male contacts</p>	
	<p><b>SGHMC20MF-PK04 Tunnel Modules</b> Pack with 4 EIA/TIA color-coded ethernet female modules + 10 female contacts</p>	
	<p><b>SGHMC20MM-PK10 Tunnel Modules</b> Pack with 10 black male modules for shielded signals + 22 male contacts</p>	
	<p><b>SGHMC20MF-PK10 Tunnel Modules</b> Pack with 10 black female modules for shielded signals + 22 female contacts</p>	

### Accessories & Tools

Spare parts		
	<p><b>SGHCL11-PK10</b> Pack with 10 Capsulocks for male and female 16amp power contacts</p>	
	<p><b>SGHCL10-PK10</b> Pack with 10 Capsulocks for male and female 32amp power contacts</p>	

Tools			
	<p><b>SGH-TLT</b> SGH Tightening Tool</p>		<p><b>SVKTOR</b> Turret positioner</p>
	<p><b>SGH-TLA</b> SGH Tool for modules insertion</p>		<p><b>SVKTINS16</b> (for size 16 pins) <b>SVKTINS18/20</b> (for size 18/20 pins) Insertion tool</p>
	<p><b>SBH-CRIMP-A</b> Hydraulic crimping tool 45kN</p>		<p><b>SVKT16GP</b> (for size 16 pins) <b>SVKT20GP</b> (for size 20 pins) Inserting guide pin</p>
	<p><b>SVKTCRIMP</b> Manual crimping tool</p>		<p><b>SVKTESTR16</b> (for size 16 pins) <b>SVKTESTR20</b> (for size 20 pins) Removal tool</p>





## **Tell us what you need and we'll build it for you**

In our mechanical workshop we are free to innovate and independently create and test new solutions, thanks to highly skilled designers and state-of-the-art machines.  
An ability of ours and a great advantage for our clients.

From basic customizations to whole new connector designs,  
we are ready to give shape to your needs.

Let's discuss your new idea together.



[www.valentininet.com](http://www.valentininet.com)







# VALENTINI

Via Asti 84/A  
10098 Rivoli (TO) Italy  
Tel: +39 0119594160

[info@syntaxnet.it](mailto:info@syntaxnet.it)  
[www.valentininet.com](http://www.valentininet.com)  
[www.sghsyntaxconnectors.com](http://www.sghsyntaxconnectors.com)  
[linkedin.com/company/valentinigroup](https://www.linkedin.com/company/valentinigroup)

**SYNTAX**<sup>®</sup>



SGH Syntax website